

MOUNTING MAINTENANCE

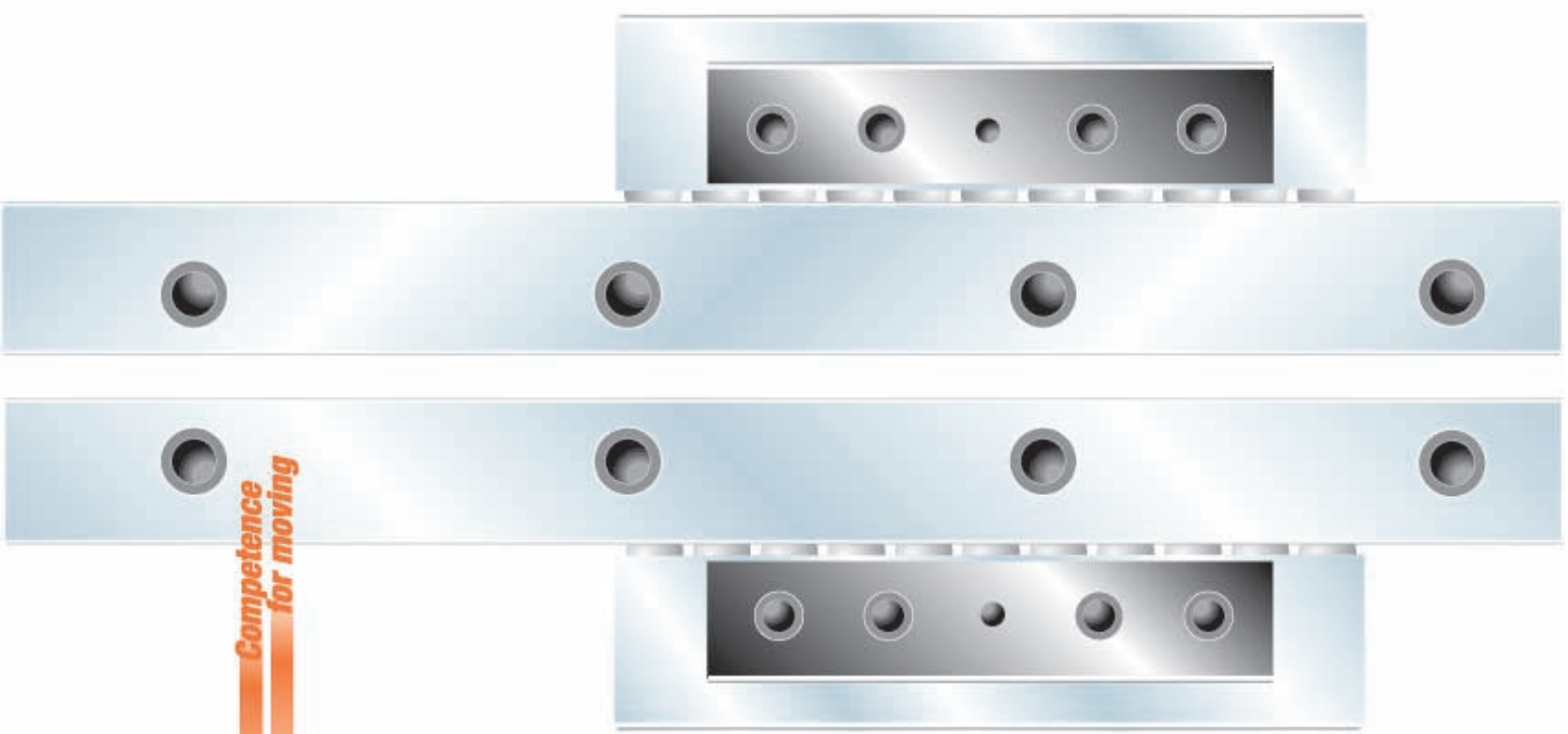

Linear guides

*Aluminium re-circulation system
Single rail
with re-circulating element*



*Competence
for moving*



Mounting instruction for linear guides with re-circulating ball element



Table of contents

	page
1. General notes	3
1.1 Used symbols	3
1.2 Due application	3
1.3 Protection and maintenance measures	3
1.4 Preparation of mounting	3
1.5 Survey on mounting setup	4
2. Mounting of rails	5
2.1 Mounting of single rails	5
2.2 Mounting of coupled single rails	6
3. Mounting of recirculating ball elements	7
4. Clearance adjustment and slide resistance	8
5. Lubrication of linear guides	9
6. Tightening torque for screwed connections	9



1. General notes

1.1 Used symbols

- Symbolizes a proceeding instruction.
-  Hints and recommendations (e.g. referring to tightening torques).
-  If the instructions are not observed there is the risk of damages or the function of the linear guide may be adversely affected.

1.2 Due application

Franke linear guides with recirculating ball element are provided for precise linear motions of loads such as in the machine construction, robot building, with portals and conveyor units. Linear guides with ball recirculation can be used in the provided temperature range of -10° up to +80°C. Franke GmbH does not take any responsibility for damages which are caused by modifications of the guides which are not described in this documentation.

1.3 Protection and maintenance measures

Until mounting Franke linear tables should be stored in the original packing which protects them from humidity and damages.

Do not use other than Franke parts for mounting and repair.

Linear guides with recirculating ball element have to be re-lubricated. Lubrication hints are found in chapter 5.

1.4 Preparation of mounting – tools and accessories

- Torque wrench
- Dial gauge
- Fastening screws
- Screw driver
- Hexagon socket screw

1.5 Survey on mounting setup

Linear guides with recirculating ball elements consist of single rails and recirculating elements which are fixed on a connection plate.

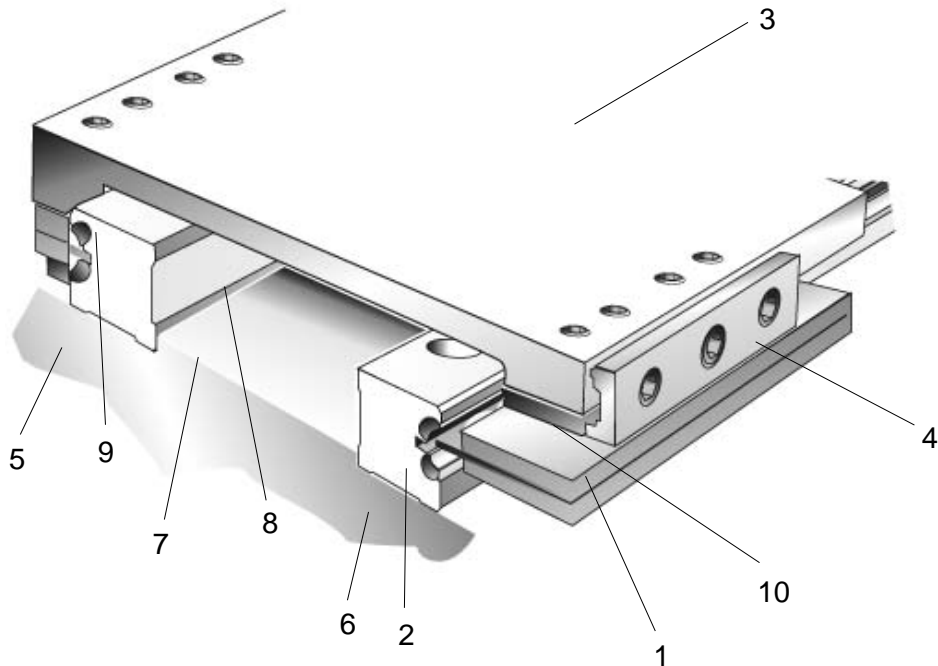

- | | |
|--------------------------|---------------------|
| 1. Recirculating element | 6. Adjustment side |
| 2. Single rail | 7. Contact shoulder |
| 3. Joining plate | 8. Contact side |
| 4. Ledge (optional) | 9. Heel |
| 5. Stationary side | 10. Marker groove |

2. Mounting of the rails

2.1 Mounting of the single rails

The rails are screwed against a contact shoulder.

Mounting of the first rail:

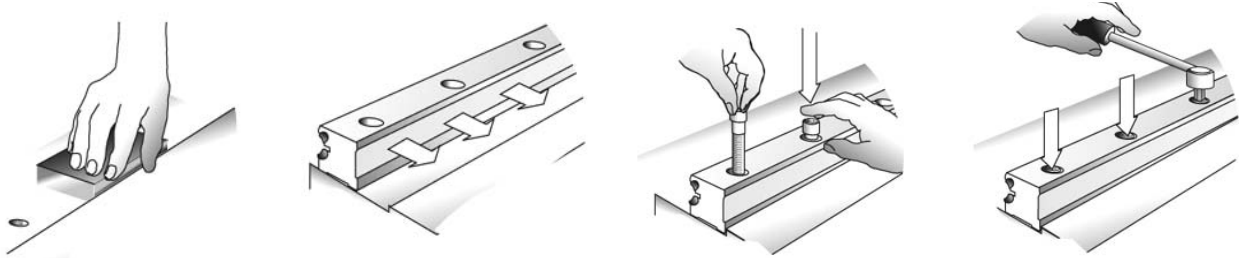

- Check the contact surfaces for contamination and damages.
- Check the linearity and parallelism of your mating structure (permissible deviation 0.04 mm over the whole stroke distance).
- Put the rail with the contact surface against the contact shoulder.
 - ☞ Please observe the mounting position of the rail: The upper side of the rail is marked by a heel.
- Tighten the screws alternately from the centre outwards.
 - ☞ Observe the prescribed tightening torques (chapter 6).

Mounting of the second rail:

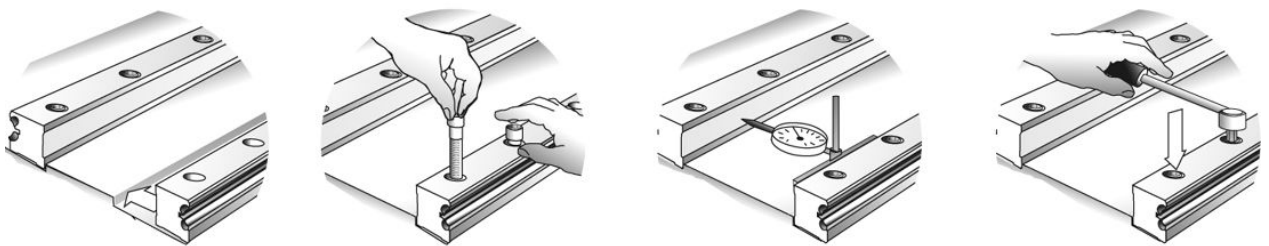

- Put the second rail in its position. Align it in parallel direction to the first rail. Tighten the screws slightly.
- Check the linearity and parallelism of the two rails. The maximum accumulated error must be < 0.06mm.
- Tighten the screws alternately from the centre outwards.
 - ☞ Observe the prescribed tightening torques (chapter 6).

2.2 Mounting of coupled single rails

The rails of a recirculating ball guide can also be composed of several single rails. Rails with a length of more than 4000mm are coupled.

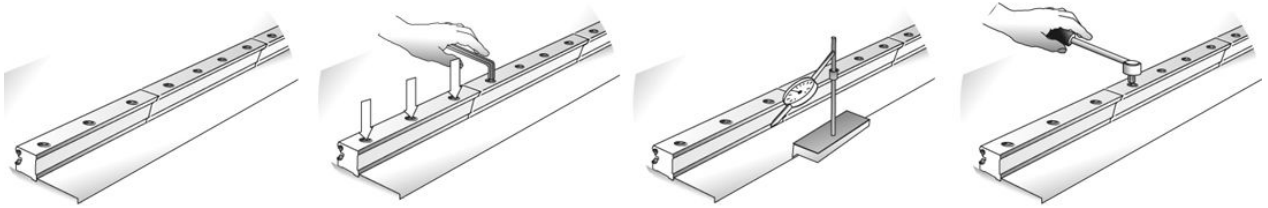

- Check the contact surfaces for dirt and damages.
 - Check the linearity and parallelism of your mating structure (max. permissible error 0.04 mm over the whole stroke distance).
 - Put the contact surface of the rail against the contact shoulder.
- ⚠ Coupled rails are particularly adapted to each other. When coupling rails please take care that they all belong to the same consignment.
- ☞ Observe the mounting position of the rails: The upper side of the rail is marked with a heel.
 - Align the rails uniformly. The mounting gap of coupled rails with bevelled joint must be at least 1 mm. A gap of 0.8-1.2 mm is permissible to compensate drilling tolerances on the rail.
 - ☞ The mounting temperature should be approximately 20°, however the guide system can be used in a temperature range of 10° up to 40°C.
 - Tighten the screws slightly beginning in the centre of the rail track. Tighten the screws of the remaining rails alternately before and behind the central rail.
 - Check the rails for linearity and parallelism. The max. accumulated error must be < 0.06 mm.
 - Tighten the screws now.
 - ☞ Observe the prescribed tightening torques (chapter 6).

3. Mounting of recirculating ball elements

The recirculating ball elements are mounted on a mating plate. Both together form the slider. When mounting we have to make a difference between the stationary side and the adjustment side.

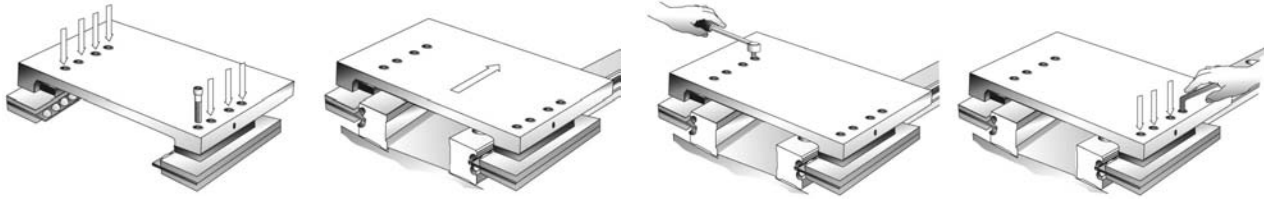

- Screw the recirculating ball elements to the joining plate. Take care that the groove-marked side of the recirculating element rests on the screw-on surface.
- Screw the rail and the slider with the stationary side against a contact shoulder.
 🖱️ Observe the prescribed tightening torques (chapter 6).
- Tighten all fastening screws on the adjustment side only slightly.
- Several recirculating elements which are arranged behind one another are aligned to each other by means of the mating plate and the contact shoulder.
- Mount the adjustment ledge on the adjustment side (optional).

4. Adjustment of clearance and slide resistance

The clearance of the guide is adjustable by means of an adjustment ledge (supplied optionally).

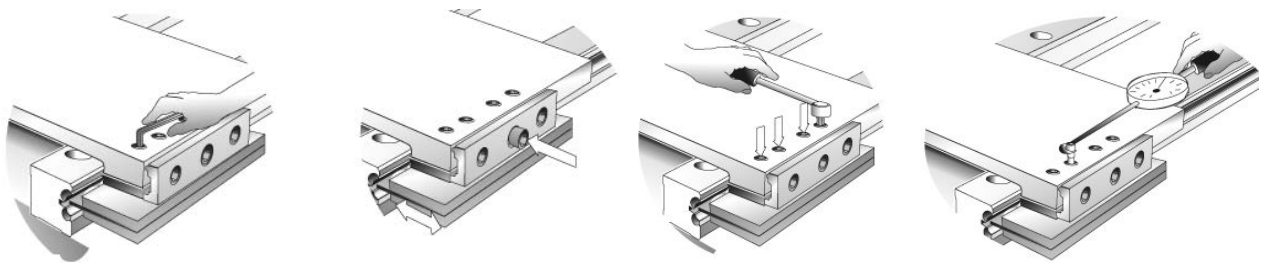

- For clearance setting loosen the fastening screws of the slider plate on the adjustment side.
- For clearance setting you can displace the recirculating element relative to the slider plate by means of the adjustment screws on the adjustment ledge.
- All fastening screws have to be tightened again after the desired clearance was set.
 - ☞ Observe the prescribed tightening torques (chapter 6).
- Measure the slide resistance in unloaded condition.
- Take the standard values from table 1. The values are given per pair of recirculating elements.
 - ☞ The values are given per pair of recirculating elements.

Slide resistance [N] FEC 10	90-120
Slide resistance [N] FEC 13	150-200

Table 1: Values of slide resistance per pair of recirculating elements

☞ for table 1:

- With multi-track systems the slide resistance of the single sliders is added up.
- With relatively big errors the dimensions and evenness of the mating structure have to be checked. With very stiff structures the standard values can be reduced by about 30%.
- After a runtime of 2-4 hours the preload and slide resistance reduces of about 40%.

5. Lubrication of the linear guide

Franke linear guides with recirculation ball elements have always to be coated by a lubricant film.

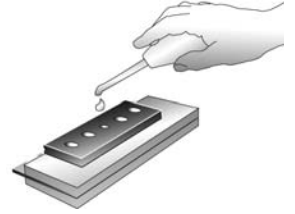

- The system should be re-lubricated every 500-700 operating hours, respectively 1-2 times per year.
- Recirculating ball elements of the series FUV10 and FUV13 have central lubrication system as standard. In this case re-lubrication is made by means of the threaded hole on the screw-on surface.
- As an alternative you can re-lubricate the guide by the external lubrication holes. Therefore the locking plug on the lubrication hole has to be removed.

Use of lubricants

- We recommend you to use fully synthetic lubricants for long-term lubrication e.g. the special grease "ISOFLEX TOPAS NCA 52" make Klüber (designation according to DIN 51502:KHC 2 N-50).
- As an alternative you can use high-grade lithium soap greases on the basis of polyalpha-olefin or mineral-based lubricant, respectively greases according to DIN 51825-K40. Take care that the lubricants are suitable for the provided application and the used materials.
- In case that you mix lubricants check the consistency of the types. Please clear these questions directly with the lubricant supplier.

6. Tightening torques for screws

Fasten the Franke linear guides with screws of quality 8.8 and washers according to DIN 433.

	FEW10/FEC10	FEC13
Screw size quality: 8.8	M8	M10
Tightening torques [Nm]	25,0	49,0

Table 2: Tightening torques [Nm]



For further information please contact our service-team.

Franke GmbH
Obere Bahnstr. 64
73431 Aalen
Germany
Tel.: 07361 /920-0
Fax.: 07361/920-120

www.franke-gmbh.com
www.franke-bearings.de
www.franke-linearguides.de
info@franke-gmbh.de

All contained informations are verified. Franke GmbH accepts no responsibility however for any damage resulting from incorrect or incomplete information contained. As our products are constantly in the process of further development, the right to technical modifications is reserved.

The company cannot take responsibility for misprints.