

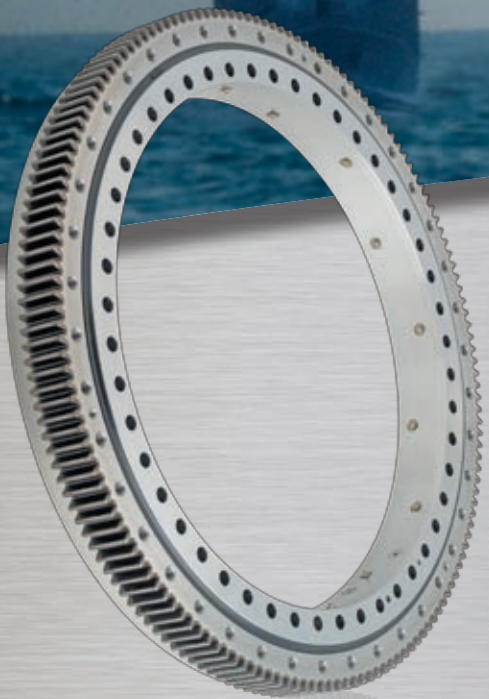

Kaydon **infinite**[™] bearing solutions



**Precision and
reliability for
air, land and sea**

When performance is critical, count on Kaydon

From the stifling deserts of the middle east to the emptiness of outer space, KAYDON® bearings are proven choices for critical applications. We've been solving tough engineering problems for the U.S. military and its allies since 1941, becoming a global leader in slewing ring and thin-section bearings. Today the Kaydon name is recognized around the world for:

- quality and precision
- high load capacity
- outstanding space utilization
- reliability in harsh environments (heat, corrosion, contamination)
- standard and custom bearings - balls, cylindrical, tapered, and sleeve
- comprehensive technical support

Meeting challenging specifications is just the beginning. For combat, recon or simple transportation, today's designs demand innovation as well as performance. Both are Kaydon specialties, thanks to top-flight engineering and manufacturing teams with all the appropriate certifications. Among these are **AS9100B, ISO 9001:2008, NADCAP** (heat treat, chemical, NDT), and the specialized accreditations of industry leaders.

Kaydon Bearings is a division of Kaydon Corporation, a U.S.-based manufacturer with annual global revenues approaching half a billion dollars. With Kaydon Bearings as your partner, you are assured of top-quality performance for a long, long time.



Kaydon bearings prove themselves every day, in a variety of aerospace/defense applications. Some examples:

Aircraft (fighter jets, helicopters, UAVs, airlift & cargo, commercial)

- landing wheels
- navigation & surveillance
- target acquisition pods
- counter-measure systems
- mast, swash plate & gearbox bearings
- propulsion & control systems
- refueling booms, winches, APUs

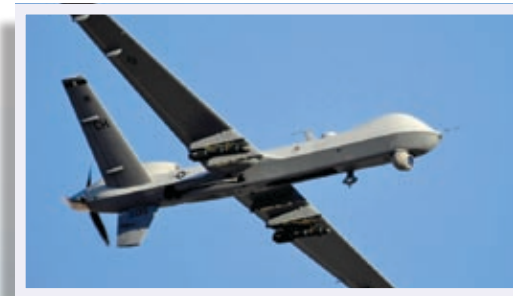

Courtesy U.S. Air Force



Ships

- missile defense
- gun mounts
- sonar, radar & communication
- carrier elevator and arresters

Ground combat and security vehicles

- turrets
- target & sighting systems
- transmission
- suspension



Weapons

- elevation & azimuth positions
- guidance & propulsion systems
- missile launchers
- gun mounts & ammunition loaders

Space

- satellites
- space station
- telescopes (e.g., Hubble)
- Mars rover

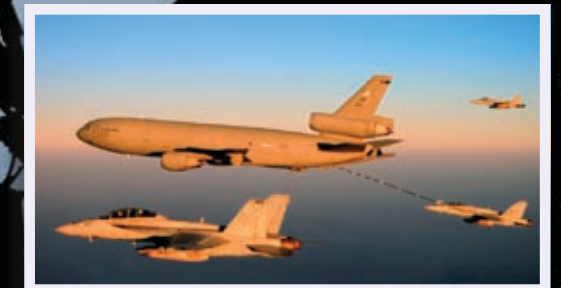
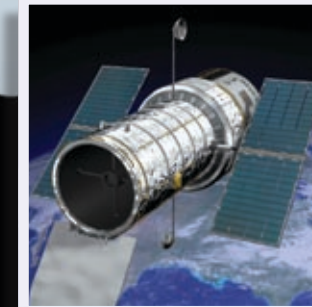

Bearings & precision assemblies for your specific requirements

For critical applications involving radial, axial or moment loads, you need Kaydon Bearings. We have a tremendous range of slewing ring bearings and thin-section bearings (a Kaydon original) and no one makes more advanced custom bearings to meet engineers' specific needs.



Slewing ring bearings

Kaydon manufactures a complete range of slewing rings from 2" to 240" in diameter. Styles include 4-point contact ball, 8-point contact ball, cross-roller, and 3-row roller. Most can be provided non-geared or geared (internal gearing on the inner or outer race).

Our large-diameter WireX® bearings are 60% lighter than steel bearings with comparable load capacity. Originally developed for military turrets, today they are also mainstays in radar and sonar equipment.

REALI-SLIM® bearings

REALI-SLIM® thin-section bearings provide high dynamic capacity and make the best use of space and weight limitations, since the cross-section stays constant as the bore diameter increases. We offer seven series of open bearings and five series of sealed bearings. Bore diameters range from 1 inch to 40 inches (20 mm to 360 mm), and many are offered in both inch and metric sizes, with materials and coatings to withstand harsh environments.

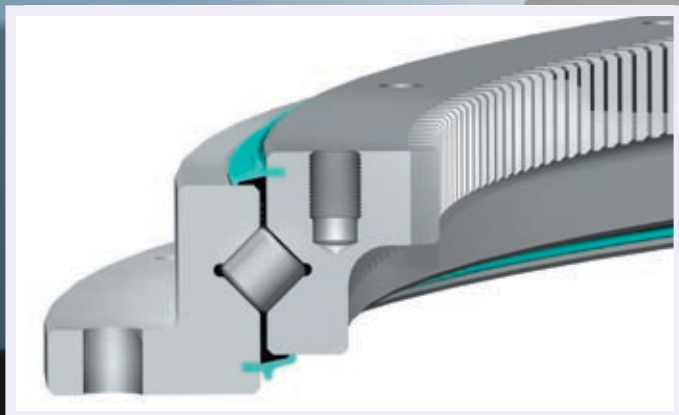
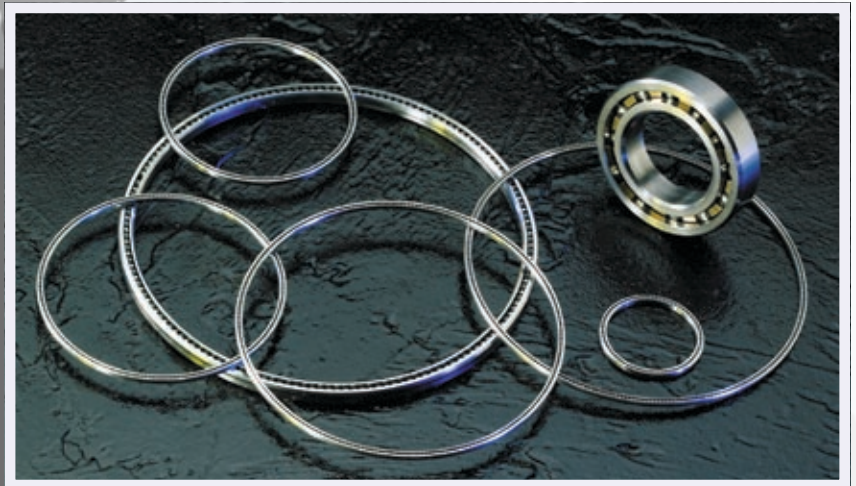

Custom designs and technical support

We can provide a wide range of rolling element bearings (ball, roller, taper, cylindrical), precision sleeves, and assemblies. Most can be customized for specific needs with flanges, retainers, integral gears, and preload settings. They are also available in a variety of materials (e.g., 52100, M50, 440C, titanium) and coatings (ENDURAKOTE® chrome plating, nickel, zinc, etc.).

Kaydon is also known for comprehensive technical support, from documentation to design software and 3-D part drawings.

**Kaydon Bearings:
on active duty since 1941**

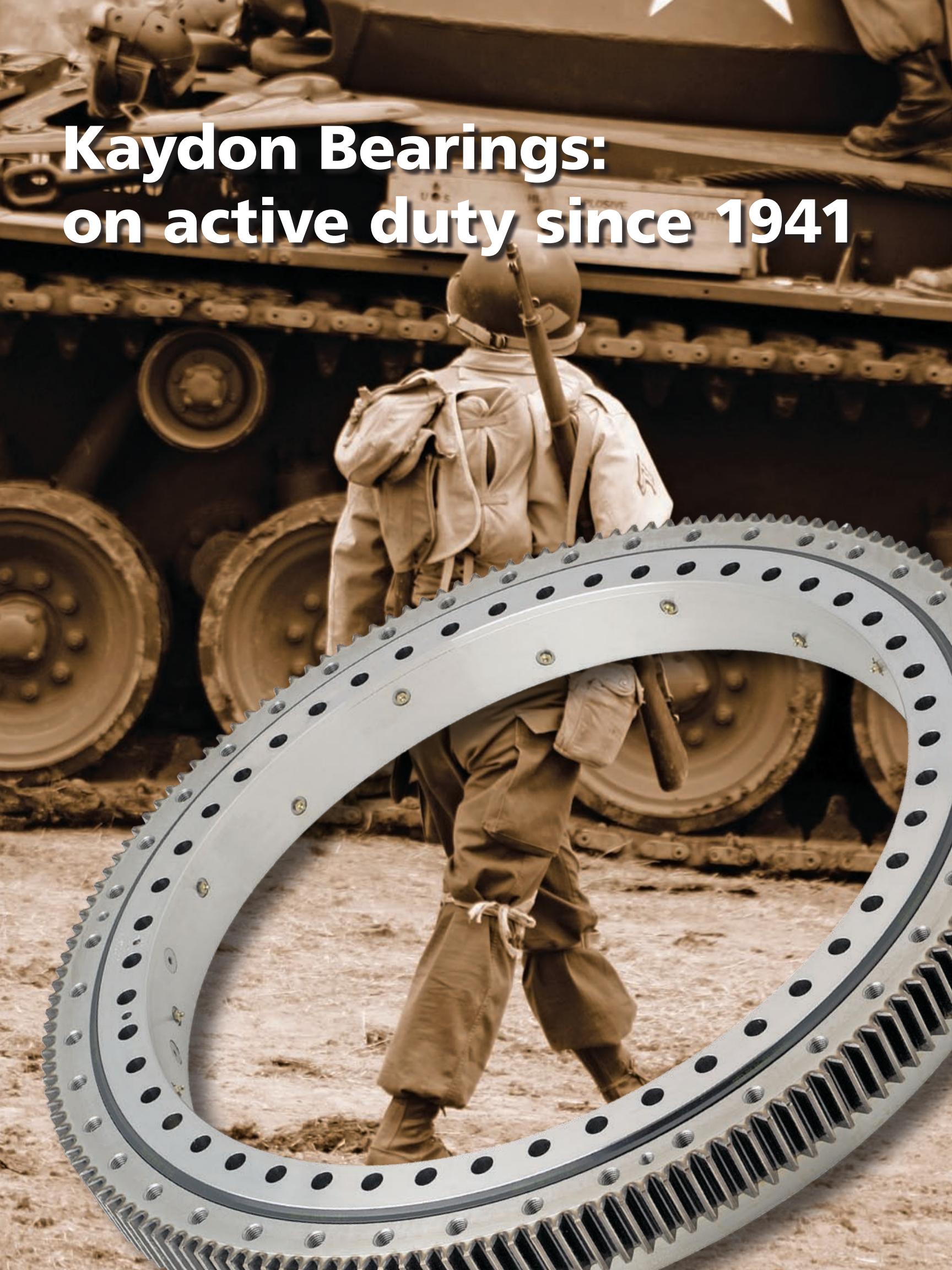



A history of service

Kaydon Bearings has been a key contributor to the national defense since World War II, when we answered the call of the U.S. Navy to produce large gun mount bearings. Over the past seven decades, our bearings have proven themselves again and again in civilian as well as military applications — in the sky, on land, at sea, and even on Mars.



KAYDON Corporation Bearings Division
2860 McCracken Street, Muskegon, Michigan 49441
Phone: (231) 755-3741 or 1-800-514-3066
Fax: (231) 759-4102, email: bearings@kaydon.com
Visit our website: www.kaydonbearings.com