

# TIMKEN®

## Super Precision Thin-Section Instrument Ball Bearings



Timken Super Precision  
A TIMKEN COMPANY SUBSIDIARY

ISO 9001 Registered  
AS9000 Certified  
D1-9000 AQS Certified

# Timken Super Precision Thin-Section Ball Bearings for Aerospace & Instrument Applications

- From .625" to 12" OD
- All ABEC Classes

Timken Super Precision leads the industry in the development and widespread acceptance of standard and special thin-section, high-precision ball bearings. Thin-section bearings, with their large complements of small diameter balls, provide greater stiffness and lower torque while permitting a significant reduction in weight and space when compared to standard section bearings. These advantages have found wide acceptance in many critical applications including ordinance and aerospace guidance systems, large diameter encoders, and radar support systems.

Bearings of Angular Contact, Conrad or Timken Super Precision's proprietary Fractured Outer Race construction are produced in sizes up to 12" in diameter.

Rings and balls are made from premium quality 440C stainless steel, 52100 or other selected alloys. Metallic, one piece phenolic, or multiple element Teflon spacers are available, as well as a variety of shield or seal configurations to optimize performance for any specific application.

Quality control, traceability and specialized metrology play a key role in assuring customer satisfaction and long-term reliability of these products. Torque testing and preload monitoring under customer specified operating conditions provide the greatest level of confidence in the successful performance of the ball bearings in their final application.

This catalog covers the full range of **Torque Tube** bearings, which with the extended inner ring are interchangeable with standard A-500 series bearings. The **Thin-Section** bearings with cross sections of 1/8", 3/6", 1/4", and 5/16", and a OD up 4.5" are covered in the main section of this catalog. Larger bearings up to 12" OD are shown on pages 26 - 33. All engineering data may be consistently applied.

- 1/8" to 3/4" Standard Cross Sections
- Special Design Configurations

## Table of Contents

### Selector Guide

Introduction .....	2
Part Numbering .....	3

### Design Configurations

Conrad Assembly - Torque Tube .....	4
Conrad Assembly - Thin Section .....	5
Angular Contact - Torque Tube .....	6
Angular Contact - Thin Section .....	7
Fractured Race - Torque Tube .....	8
Fractured Race - Thin Section .....	9
Configuration Availability.....	10
Special Designs .....	12

### Engineering Data

Materials .....	14
Retainers .....	15
Shields and Seals .....	16
Radial Play, End Play and Contact Angle .....	17
Tolerances .....	18
Lubrication .....	20
Coding for Shaft and Housing Fits .....	22
Loading Rates .....	23
Preload, Deflection, Torque .....	24

### Large Thin Section Bearings

SBB Introduction .....	26
SBB Part Numbering .....	27
Conrad Assembly .....	28
Angular Contact .....	30
Fractured Race Commercial Series .....	32

Inch-to-Metric Conversion .....	34
---------------------------------	----

## Bearing Types

### Conrad Assembly

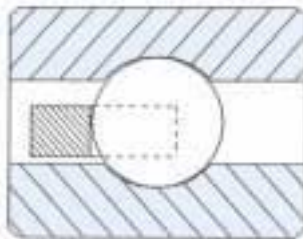

General purpose choice for average-speed and multi-directional, moderate-load applications. Limited retainers offered with option of removable seals and shields.

### Angular Contact

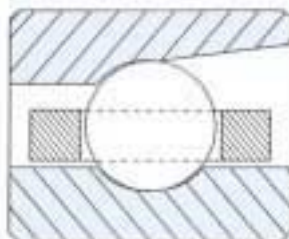

Highest thrust capacity for uni-directional loads. Preload required to develop radial capacity. Well constructed for preloaded pairs in gimbal or spin positions. Full range of retainer types available.

### Fracture Race

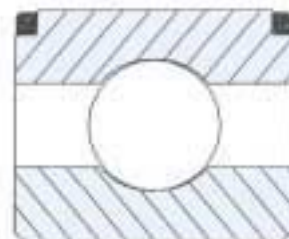

Fractured race construction allows greater multi-directional loads and speeds than Conrad type. Suggested full ball complement or one piece retainer design for higher radial loads will accommodate thrust or moment loads with special outer race fits. Complete retainer selection available.

# Part Numbering

CODE POSITION	1	2	3	4	5	6	7	8	9
FEATURE	Material	Size	Type	Features	Tolerance	Radial Play	Lubrication	Dimensional Code	Duplexed Pair
EXAMPLE A	S	1724	BM	E	5	—	—	—	—
EXAMPLE B	S	1014	MC	H	7	P38	LYC5	ZDM	DB10

### 1. Material:

- S = AISI 440C Stainless Steel
- C = SAE 52100 Chrome Steel

### 2. Bearing Size:

This number designates the basic envelope dimensions of the bearing. For all Thin Section and Torque Tube bearings, the size code is based on 1/16" increments for both bore and OD.

Example: 1724 - this bearing has a bore of 17/16" and an OD of 24/16" ( 1.0625 x 1.5000 )

### 3. Type:

- B = Fractured outer ring
- M = Angular contact non-separable, phenolic retainer
- MC = One-piece snap-type phenolic retainer
- MCK = One-piece molded snap-type Minapar II retainer
- MR = Angular contact, non-separable, full ball complement
- MS = Angular contact, non-separable, steel retainer
- MSO = Angular contact, non-separable toroid ball separators
- MT = Angular contact, non-separable aluminum bronze
- S = Thru-hole stainless steel retainer
- SO = Teflon-toroid ball separators
- ST = Teflon-slug separators

### 4. Features:

- H = Single shield
- HH = Double shield
- I = Integral shield
- Z = Single seal
- ZZ = Double seal
- E = Extended inner ring

### 5. Tolerance:

- 1 = Class 1    5 = ABEC 5T
- 3 = Class 3    7 = ABEC 7T

### 6. Radial Play:

P followed by numbers indicates radial play range in ten-thousandths of an inch. Examples:

- P28 indicates radial play of .0002" to .0008".
- P515 indicates radial play of .0005" to .0015".

### 7. Lubrication:

- LD no lubrication or dry bearings.
- LO followed by a number indicates specified oil lubrication.
- LG followed by a number indicates specified grease lubrication.
- LY followed by a number indicates other MPB approved lubricants.
- LOV or LYV followed by a number indicates specified oil to be vacuum impregnated into the retainer.
- LOC or LYC followed by a number indicates specified oil to be used and the bearing centrifuged.
- LGF or LYF followed by a number indicates film of a specific grease.

MPB code numbers for the most frequently specified lubricants are listed on page 21.

### 8. Dimensional Coding:

- ZO = graded OD's only
- ZB = graded bores only
- ZD = graded bores and OD's
- ZDM = graded for duplexed pairs having matched bores and OD's.

Standard dimensional grading is in increments of .0001". "X" prefix for .000050" increments.

### 9. Preloaded Pairs:

- DB = back-to-back mounting
- DF = face-to-face mounting
- DT = tandem mounting

Numbers following letter code indicate nominal preload in pounds.

### SPECIAL DESIGNS

Bearings with modified dimensions, special designs and assemblies are designated by a sequential alpha/numeric drawing number.

## WARNING!

Proper bearing installation, maintenance, and handling practices are critical. • **ALWAYS** follow proper bearing installation, maintenance, and handling practices • **NEVER** remove the rolling elements of any part of a bearing assembly • **NEVER** substitute an unauthorized or unapproved bearing in any installation • **NEVER** remove a bearing from its package until ready to use. Store in a clean, dry area.

Failure to follow equipment manufacturers' instructions, maintain proper lubrication and/or follow any of these directives can cause equipment failure, creating the risk of serious bodily injury.

# Conrad Assembly

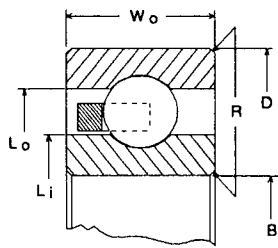

MPB Thin section and Torque Tube Conrad Bearings are available in sizes up to 6.0" OD. The ball grooves are honed for precision, low torque, and quiet operation. The deep groove construction allows for handling of radial, thrust and combination loads. While offered primarily with 440C stainless steel rings and balls and with a one-piece fully machined snap-in phenolic cage, other material and separator options are available for specific application requirements. Some of the more common design variations are discussed below. See pages 10 and 11 for availability information.

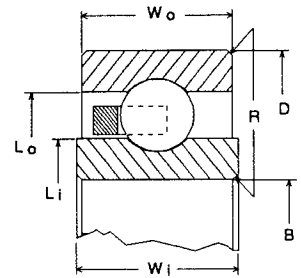

Example: P/N's: S2630MC7 and S2630MCE5

## Torque Tube Series

Basic Bearing Size	Bore B	O.D. D	Width		Land Diameter		Radius R	Ball Complement		Load Ratings (lbs.)			Approx. Weight (grams)
			W <sub>o</sub>	W <sub>i</sub>	L <sub>i</sub>	L <sub>o</sub>		No.	Size	Radial		Thrust	
										C	R <sub>s</sub>	T <sub>s</sub>	
1017	.6250	1.0625	.2500	.2810	.780	.918	.015	12	1/8	642	351	494	14.5
1219	.7500	1.1875	.2500	.2810	.893	1.043	.015	12	1/8	628	362	386	16.8
1421	.8750	1.3125	.2500	.2810	1.020	1.168	.015	14	1/8	679	433	481	19.0
1724	1.0625	1.5000	.2500	.2810	1.210	1.360	.015	18	1/8	775	572	582	22.7
2128	1.3125	1.7500	.2500	.2810	1.458	1.606	.015	20	1/8	797	651	683	27.2
2532	1.5625	2.0000	.2500	.2810	1.707	1.856	.015	24	1/8	867	795	819	31.8
2936	1.8125	2.2500	.2500	.2810	1.947	2.097	.015	28	1/8	932	940	911	36.3
3342	2.0625	2.6250	.2500	.2810	2.262	2.412	.015	32	1/8	985	1087	1042	54.4
3746	2.3125	2.8750	.2500	.2810	2.521	2.663	.015	34	1/8	1002	1164	1156	59.0
4152	2.5625	3.2500	.3125	.3750	2.784	3.010	.015	26	3/16	1838	1903	2097	100.0
4556	2.8125	3.5000	.3125	.3750	3.034	3.257	.015	28	3/16	1894	2066	2373	109.0
4962	3.0625	3.8750	.3125	.3750	3.377	3.600	.015	32	3/16	2020	2382	2621	118.0

R = The maximum radius of shaft or housing fillet that the bearing corner will clear.  
 C = Dynamic radial capacity @ 33 1/3 RPM for 2500 hours average life (L-10 life is 500 hours).  
 R<sub>s</sub> = Static radial capacity.  
 T<sub>s</sub> = Static thrust capacity.

For larger sizes with OD up to 12", see pages 28-29.

## Design Variations

All Torque Tube series bearings and some Thin Section bearings may be ordered with extended inner rings. Torque Tube bearings with the extended inner are interchangeable with standard A-500 series bearings.

### Retainers

While the one-piece fully machined snap-in phenolic cage is the standard separator for this design, several other separator types are available. These include the Minapar II<sup>®</sup> molded plastic (MCK) retainer, and Teflon slugs (ST) for low breakaway torque. Additional data - page 15.

### Shields and Seals

Conrad bearings can be supplied with molded lip shields or contact seals. These light contact seals are normally used for instrument or industrial applications exposed to severe contamination.

Buna-N (Nitrile) rubber, standard in both designs, is suitable for temperatures up to 225°F. It is compatible with most standard instrument bearing lubricants. Viton rubber, suitable for temperatures to over 400°F, is available on special order. For additional data refer to page 16.

# Conrad Assembly

## Thin Section Series

Basic Bearing Size	Bore B	O.D. D	Width W <sub>o</sub> W <sub>i</sub>		Land Diameter L <sub>i</sub> L <sub>o</sub>		Radius R	Ball Complement No.    Size		Load Ratings (lbs.)			Approx. Weight (grams)
										Radial		Thrust	
										Dynamic	Static	Static	
										C	R <sub>s</sub>	T <sub>s</sub>	
610	.3750	.6250	.1560	—	.458	.542	.010	14	1/16	170	79	112	2.7
812	.5000	.7500	.1560	—	.588	.672	.010	17	1/16	178	94	129	3.6
1014	.6250	.8750	.1560	—	.713	.797	.010	20	1/16	198	121	161	4.1
1216	.7500	1.0000	.1560	—	.838	.922	.010	24	1/16	215	148	199	5.0
1418	.8750	1.1250	.1560	—	.958	1.042	.010	26	1/16	220	162	211	5.4
1622	1.0000	1.3750	.1875	—	1.140	1.235	.015	21	3/32	481	378	727	13.1
1721	1.0625	1.3125	.1560	—	1.145	1.230	.010	32	1/16	242	203	244	6.8
2024	1.2500	1.5000	.1560	—	1.333	1.417	.010	36	1/16	254	231	293	7.7
2226	1.3750	1.6250	.1560	—	1.458	1.542	.010	40	1/16	267	258	326	8.6
2428	1.5000	1.7500	.1560	—	1.583	1.667	.010	44	1/16	280	285	358	9.1
2430	1.5000	1.8750	.1875	—	1.640	1.735	.015	29	3/32	549	541	1020	18.5
2630	1.6250	1.8750	.1560	—	1.708	1.792	.010	48	1/16	293	312	392	10.0
3240	2.0000	2.5000	.2500	—	2.175	2.325	.025	30	1/8	952	1016	1003	40.8
3242	2.0000	2.6250	.3125	—	2.219	2.406	.040	25	5/32	1310	1279	1454	63.5
4048	2.5000	3.0000	.2500	—	2.675	2.825	.025	36	1/8	1027	1237	1205	50.0
4050	2.5000	3.1250	.3125	—	2.719	2.906	.040	30	5/32	1412	1563	1702	77.1
4856	3.0000	3.5000	.2500	—	3.175	3.325	.025	43	1/8	1117	1493	1441	59.0
4858	3.0000	3.6250	.3125	—	3.219	3.406	.040	35	5/32	1508	1846	2043	90.7
5664	3.5000	4.0000	.2500	—	3.675	3.825	.025	49	1/8	1184	1715	1652	63.5
5666	3.5000	4.1250	.3125	—	3.719	3.906	.040	40	5/32	1599	2129	2346	109.0
6472	4.0000	4.5000	.2500	—	4.175	4.325	.025	55	1/8	1251	1936	1853	72.6

R = The maximum radius of shaft or housing fillet that the bearing corner will clear.  
 C = Dynamic radial capacity @ 33 1/3 RPM for 2500 hours average life (L-10 life is 500 hours).  
 R<sub>s</sub> = Static radial capacity.  
 T<sub>s</sub> = Static thrust capacity.

For larger sizes with OD up to 12", see pages 28-29.

## Standard Specifications

### Tolerances

MPB manufactures Thin Section and Torque Tube bearings according to AFBMA specifications, where applicable. Tolerances vary with the size and precision level, and are shown on page 19.

### Radial Play

Standard radial play is defined on page 18.

### Lubrication

An excess of MIL-L-6085 instrument oil is provided, except for double-sealed bearings (ZZ), which are provided with Beacon 325 grease. Other lubricants are available upon request. See page 20.

### Packaging

Individual plastic bag.

# Angular Contact

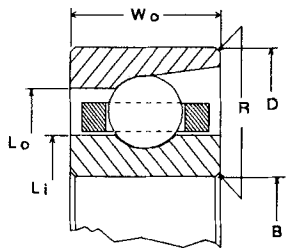

MPB Thin Section and Torque Tube Angular Contact Bearings have been developed to offer a maximum ball complement with a one piece precision machined retainer and are available in sizes up to 6.0" OD. The ball grooves are honed for precision, low torque, and quiet operation. The large ball complement, combined with a relatively high contact angle, maximizes axial stiffness. Rings and balls are normally 440C stainless steel, but other material options are available for specific applications. Some of the more common design variations are discussed below.

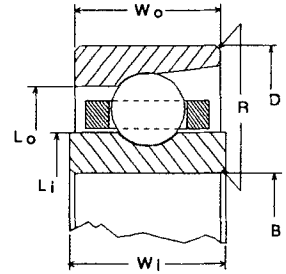

Example: P/N's: S2630M7 and S2630ME7

## Torque Tube Series

Basic Bearing Size	Bore B	O.D. D	Width		Land Diameter		Radius R	Ball Complement		Load Ratings (lbs.)			Approx. Weight (grams)
			W <sub>o</sub>	W <sub>i</sub>	L <sub>i</sub>	L <sub>o</sub>		No.	Size	Radial		Thrust	
										Dynamic C	Static R <sub>s</sub>	Static T <sub>s</sub>	
1017	.6250	1.0625	.2500	.2810	.780	.918	.015	16	1/8	768	460	613	14.5
1219	.7500	1.1875	.2500	.2810	.893	1.043	.015	18	1/8	813	522	575	16.8
1421	.8750	1.3125	.2500	.2810	1.020	1.168	.015	20	1/8	850	606	634	19.0
1724	1.0625	1.5000	.2500	.2810	1.210	1.360	.015	24	1/8	926	748	714	22.7
2128	1.3125	1.7500	.2500	.2810	1.458	1.606	.015	28	1/8	984	895	882	27.2
2532	1.5625	2.0000	.2500	.2810	1.707	1.856	.015	34	1/8	1080	1106	1070	31.8
2936	1.8125	2.2500	.2500	.2810	1.947	2.097	.015	38	1/8	1128	1252	1138	36.3
3342	2.0625	2.6250	.2500	.2810	2.262	2.412	.015	44	1/8	1203	1468	1320	54.4
3746	2.3125	2.8750	.2500	.2810	2.521	2.663	.015	48	1/8	1245	1614	1505	59.0
4152	2.5625	3.2500	.3125	.3750	2.784	3.010	.015	36	3/16	2302	2670	3047	100.0
4556	2.8125	3.5000	.3125	.3750	3.034	3.257	.015	39	3/16	2380	2915	3462	109.0
4962	3.0625	3.8750	.3125	.3750	3.377	3.600	.015	42	3/16	2440	3166	3610	118.0

R = The maximum radius of shaft or housing fillet that the bearing corner will clear.

C = Dynamic radial capacity @ 33 1/3 RPM for 2500 hours average life (L-10 life is 500 hours).

R<sub>s</sub> = Static radial capacity.

T<sub>s</sub> = Static thrust capacity.

For larger sizes with OD up to 12", see pages 28-29.

## Design Variations

All Torque Tube series bearings and some Thin Section bearings may be ordered with extended inner rings. Torque Tube bearings with the extended inner are interchangeable with standard A-500 series bearings.

### Retainers

The Angular Contact design allows for a wide range of separator options. The standard retainer is fully machined reinforced phenolic. This may be replaced with other machined material designs, or by Teflon slugs (ST) or toroids (SO) for low torque. Additional data - page 15.

### Shields and Seals

Angular Contact bearings are not offered with shields or seals as standard options. If your application requires both angular contact design and shields or seals, please consult MPB Product Engineering.

A chart showing the more common available design configurations is presented on pages 10-11.

# Angular Contact

## Thin Section Series

Basic Bearing Size	Bore B	O.D. D	Width W <sub>o</sub> W <sub>i</sub>		Land Diameter L <sub>i</sub> L <sub>o</sub>		Radius R	Ball Complement No.    Size		Load Ratings (lbs.)			Approx. Weight (grams)
										Radial		Thrust	
										Dynamic C	Static R <sub>s</sub>	Static T <sub>s</sub>	
610	.3750	.6250	.1560	—	.458	.542	.010	16	1/16	186	90	128	2.7
812	.5000	.7500	.1560	—	.588	.672	.010	21	1/16	212	124	169	3.6
1014	.6250	.8750	.1560	—	.713	.797	.010	24	1/16	222	145	193	4.1
1216	.7500	1.0000	.1560	—	.838	.922	.010	30	1/16	250	185	249	5.0
1418	.8750	1.1250	.1560	—	.958	1.042	.010	32	1/16	252	200	260	5.4
1622	1.0000	1.3750	.1875	—	1.140	1.235	.015	28	3/32	584	504	969	13.1
1721	1.0625	1.3125	.1560	—	1.145	1.230	.010	38	1/16	272	241	289	6.8
2024	1.2500	1.5000	.1560	—	1.333	1.417	.010	44	1/16	290	282	359	7.7
2226	1.3750	1.6250	.1560	—	1.458	1.542	.010	48	1/16	302	309	391	8.6
2428	1.5000	1.7500	.1560	—	1.583	1.667	.010	52	1/16	313	337	424	9.1
2430	1.5000	1.8750	.1875	—	1.640	1.735	.015	40	3/32	680	747	1389	18.5
2630	1.6250	1.8750	.1560	—	1.708	1.792	.010	56	1/16	324	364	457	10.0
3240	2.0000	2.5000	.2500	—	2.175	2.325	.025	42	1/8	1177	1397	1293	40.8
3242	2.0000	2.6250	.3125	—	2.219	2.406	.040	34	5/32	1603	1730	1940	63.5
4048	2.5000	3.0000	.2500	—	2.675	2.825	.025	52	1/8	1296	1756	1605	50.0
4050	2.5000	3.1250	.3125	—	2.719	2.906	.040	42	5/32	1762	2177	2336	77.1
4856	3.0000	3.5000	.2500	—	3.175	3.325	.025	62	1/8	1408	2116	1917	59.0
4858	3.0000	3.6250	.3125	—	3.219	3.406	.040	50	5/32	1906	2624	2863	90.7
5664	3.5000	4.0000	.2500	—	3.675	3.825	.025	70	1/8	1455	2340	1853	63.5
5666	3.5000	4.1250	.3125	—	3.719	3.906	.040	58	5/32	1985	2944	2722	109.0
6472	4.0000	4.5000	.2500	—	4.175	4.325	.025	80	1/8	1556	2690	2120	72.6

R = The maximum radius of shaft or housing fillet that the bearing corner will clear.

C = Dynamic radial capacity @ 33 1/3 RPM for 2500 hours average life (L-10 life is 500 hours).

R<sub>s</sub> = Static radial capacity.

T<sub>s</sub> = Static thrust capacity.

For larger sizes with OD up to 12", see pages 28-29.

## Standard Specifications

### Tolerances

MPB manufactures Thin Section and Torque Tube bearings according to AFBMA specifications, where applicable. Tolerances vary with the size and precision level, and are shown on page 19.

### Radial Play

Standard radial play is defined on page 18.

### Lubrication

An excess of MIL-L-6085 instrument oil is provided, except for double-sealed bearings (ZZ), which are provided with Beacon 325 grease. Other lubricants are available upon request. See page 20.

# Fractured Race

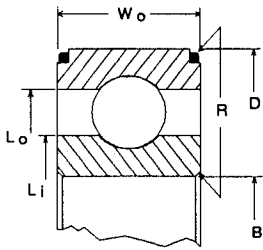

MPB Fractured Race Bearings have outer races that are radially fractured in one location. This permits the race to be opened for complete flexibility in the choice of ball complement and separator in a deep groove radial bearing. High strength, stainless steel holding bands are then pressed on the ground shoulders to retain tight abutment and perfect alignment of the fractured surface during handling and normal operation. Fractured race bearings are available in both full ball complement and retainer configurations. Some of the more common design variations are discussed below.

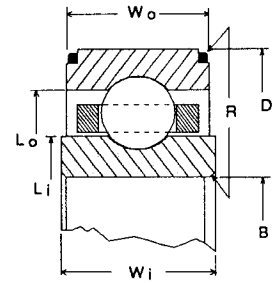

Example P/N's: S1724B5 and S1724BME5

## Torque Tube Series

Basic Bearing Size	Bore B	O.D. D	Width		Land Diameter		Radius R	Full Ball Complement*		Load Ratings** (lbs.)			Approx. Weight (grams)
			W <sub>o</sub>	W <sub>i</sub>	L <sub>i</sub>	L <sub>o</sub>		No.	Size	Radial		Thrust	
										Dynamic C	Static R <sub>s</sub>	Static T <sub>s</sub>	
1017	.6250	1.0625	.2500	.2810	.780	.918	.015	21	1/8	918	600	—	14.5
1219	.7500	1.1875	.2500	.2810	.893	1.043	.015	24	1/8	980	706	—	16.8
1421	.8750	1.3125	.2500	.2810	1.020	1.168	.015	27	1/8	1035	814	—	19.0
1724	1.0625	1.5000	.2500	.2810	1.210	1.360	.015	32	1/8	1117	991	—	22.7
2128	1.3125	1.7500	.2500	.2810	1.458	1.606	.015	38	1/8	1201	1207	—	27.2
2532	1.5625	2.0000	.2500	.2810	1.707	1.856	.015	44	1/8	1277	1422	—	31.8
2936	1.8125	2.2500	.2500	.2810	1.947	2.097	.015	50	1/8	1349	1638	—	36.3
3342	2.0625	2.6250	.2500	.2810	2.262	2.412	.015	58	1/8	1440	1924	—	54.4
3746	2.3125	2.8750	.2500	.2810	2.521	2.663	.015	64	1/8	1503	2140	—	59.0
4152	2.5625	3.2500	.3125	.3750	2.784	3.010	.015	48	3/16	2781	3545	—	100.0
4556	2.8125	3.5000	.3125	.3750	3.034	3.257	.015	52	3/16	2876	3869	—	109.0
4962	3.0625	3.8750	.3125	.3750	3.377	3.600	.015	58	3/16	3019	4354	—	118.0

R = The maximum radius of shaft or housing fillet that the bearing corner will clear.  
 C = Dynamic radial capacity @33 1/3 RPM for 2500 hours average life (L-10 life is 500 hours).

R<sub>s</sub> = Static radial capacity.

T<sub>s</sub> = Static thrust capacity. No values are shown since fractured bearings are designed primarily for radial or combination load.

\* For Phenolic retainer configurations see the Angular Contact series for ball complement and C and R<sub>s</sub> ratings. For other options consult the factory.

\*\* Load ratings shown for full ball complement bearings.

## Design Variations

All Fractured Race Torque Tube and some Thin Section series bearings may be ordered with extended inner rings. Torque Tube bearings with the extended inner are interchangeable with standard A-500 series bearings.

### Retainers

The fractured race design allows for the inclusion of any (or no) separator. Where integral shields are specified, however, only Teflon slug (ST). Additional data - page 15.

### Shields and Seals

The unique integral shield design is the only closure that may be used with the fractured race bearings. For additional data refer to page 16.

A chart showing the more common available design configurations is presented on pages 10-11.



# Fractured Race

## Thin Section Series

Basic Bearing Size	Bore B	O.D. D	Width		Land Diameter		Radius R	Full Ball Complement *		Load Ratings ** (lbs.)			Approx. Weight (grams)
			W <sub>o</sub>	W <sub>i</sub>	L <sub>i</sub>	L <sub>o</sub>		No.	Size	Radial		Thrust	
										Dynamic C	Static R <sub>s</sub>	Static T <sub>s</sub>	
610	.3750	.6250	.1560	—	.458	.542	.010	24	1/16	244	136	—	2.7
812	.5000	.7500	.1560	—	.588	.672	.010	31	1/16	276	183	—	3.6
1014	.6250	.8750	.1560	—	.713	.797	.010	37	1/16	298	224	—	4.1
1216	.7500	1.0000	.1560	—	.838	.922	.010	43	1/16	317	265	—	5.0

R = The maximum radius of shaft or housing fillet that the bearing corner will clear.  
 C = Dynamic radial capacity @33 1/3 RPM for 2500 hours average life (L-10 life is 500 hours).

R<sub>s</sub> = Static radial capacity.

T<sub>s</sub> = Static thrust capacity. No values are shown since fractured bearings are designed primarily for radial or combination load.

\* For Phenolic retainer configurations see the Angular Contact series for ball complement and C and R<sub>s</sub> ratings. For other options consult the factory.

\*\* Load ratings shown for full ball complement bearings.

### How is it Produced?

1. The outer race is scored on the O.D. prior to heat treating. Inner and outer races are finish ground to high precision tolerances and paired for size. Ball size is selected for desired internal clearance.

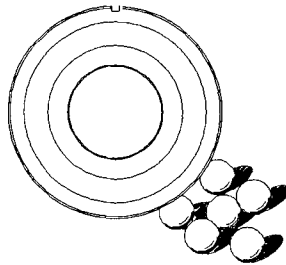

3. Special tools open the outer race sufficiently so that it may be assembled over balls, retainer (if one is used) and inner race. Release of expanding force allows outer race to close tightly.

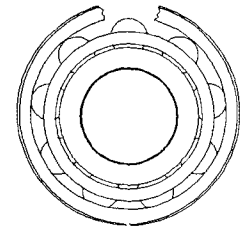

2. The outer race is fractured by our special process. This step allows subsequent assembly of a full ball complement or a maximum ball complement in a one piece retainer without the use of loading slots or counterbored races.

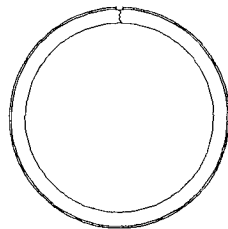

4. Holding wires are pressed onto shoulder grooves on the O.D. of the outer race to prevent opening of the outer race during handling and installation of the bearing.

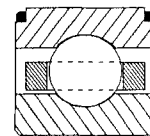

### Standard Specifications

#### Tolerances

MPB manufactures Thin Section and Torque Tube bearings according to AFBMA specifications, where applicable. Tolerances vary with the size and precision level, and are shown on page 19.

#### Radial Play

Standard radial play is defined on page 18.













#### Lubrication

An excess of MIL-L-6085 instrument oil is provided, except for integral-shielded configurations (BI), which are provided with Beacon 325 grease. Other lubricants are available upon request. See page 21.

#### Packaging

Individual plastic bag.

# Configuration Availability

Conrad Assembly												Basic Size	Bore	O.D.
MC	MCE	MCK	MCKE	MCHH	MCHHE	MCKHH	MCKHHE	ST	STE	STHH	STHHE			
•	•			•	•			•	•	•	•	1017	.6250	1.0625
•	•	•	•	•	•	•	•	•	•	•	•	1219	.7500	1.1875
•	•			•	•			•	•	•	•	1421	.8750	1.3125
•	•	•	•	•	•	•	•	•	•	•	•	1724	1.0625	1.5000
•	•			•	•			•	•	•	•	2128	1.3125	1.7500
•	•	•	•	•	•	•	•	•	•	•	•	2532	1.5625	2.0000
•	•			•	•			•	•	•	•	2936	1.8125	2.2500
•	•			•	•			•	•	•	•	3342	2.0625	2.6250
•	•			•	•			•	•	•	•	3746	2.3125	2.8750
•	•			•	•			•	•	•	•	4152	2.5625	3.2500
•	•			•	•			•	•	•	•	4556	2.8125	3.5000
•	•			•	•			•	•	•	•	4962	3.0625	3.8750
														
•	•	•	•	•	•	•	•	•	•	•	•	610	.3750	.6250
•	•	•	•	•	•	•	•	•	•	•	•	812	.5000	.7500
•	•	•	•	•	•	•	•	•	•	•	•	1014	.6250	.8750
•	•	•	•	•	•	•	•	•	•	•	•	1216	.7500	1.0000
•	•				•			•	•	•	•	1418	.8750	1.1250
•												1622	1.0000	1.3750
•	•			•	•			•	•	•	•	1721	1.0625	1.3125
•	•			•	•			•	•	•	•	2024	1.2500	1.5000
•	•			•	•			•	•	•	•	2226	1.3750	1.6250
•	•			•	•			•	•	•	•	2428	1.5000	1.7500
•												2430	1.5000	1.8750
•	•			•	•			•	•	•	•	2630	1.6250	1.8750
•				•				•	•	•		3240	2.0000	2.5000
•								•				3242	2.0000	2.6250
•				•				•		•		4048	2.5000	3.0000
•				•				•		•		4050	2.5000	3.1250
•								•				4856	3.0000	3.5000
•								•				4858	3.0000	3.6250
•								•				5664	3.5000	4.0000
•								•				5666	3.5000	4.1250
•								•				6472	4.0000	4.5000

• Standard configurations available

Please Note:  
 - For other available options refer to pages 15 and 16.  
 - All shielded bearings also available with seals.



# Special Designs

## Integral Bearing Assemblies

### HOW CAN MPB HELP YOU SOLVE YOUR BEARING PROBLEM?

- Let MPB look at the proposed design in the early stages so that the bearing can be sized properly and the most economical bearing assembly used.
- Where possible, use standard catalog bearings when performance and cost objectives can be met with a minimum amount of compromise in overall requirements.
- Be alert to the possibilities of making substantial savings and improvements in performance through the use of special bearings where unusual features can be incorporated by integrating the bearing components with the shaft and housing. Many times, the final design is surprisingly simple and performance is improved.

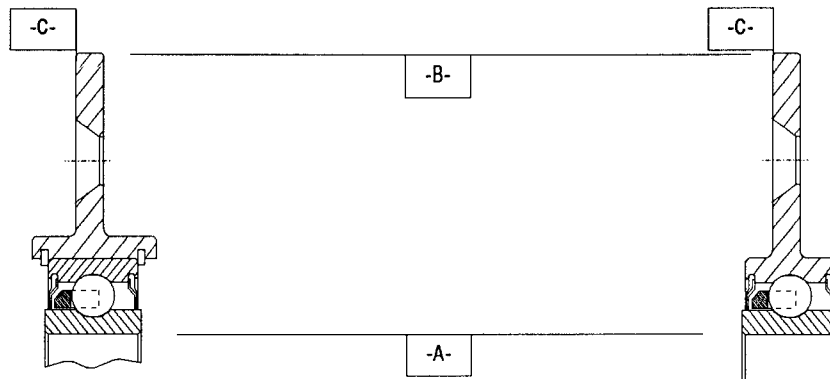

**ORIGINAL DESIGN**

1. Flanged housing.
2. Bore ground for close bearing fit.
3. Two retaining rings and grooves.

**FINAL DESIGN**

1. Flange integral with outer ring.
2. Reduced width.
3. Better runout control -B- to -A- and -C- to -A-.
4. Cost reduction — Fewer components and operations.

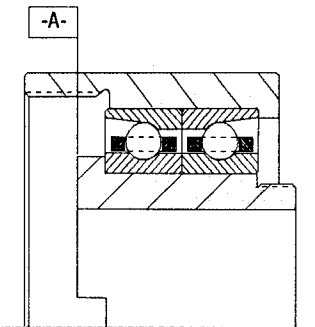

**ORIGINAL DESIGN**

1. Discrete, preloaded, angular contact bearings.
2. Precision bearing fit attained with precisely ground housing shoulder, counterbore, shaft shoulder, outside diameter and adhesive joints.
3. High contamination potential.
4. Marginal control of surface -A- runout and moment loading rigidity.

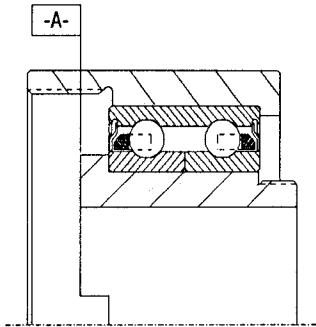

**INTERIM DESIGN**

1. Shielded, preloaded, cartridge bearing.
2. Assembly simplified and risk of bearing contamination decreased.
3. Increased control of surface -A- runout and moment loading rigidity.

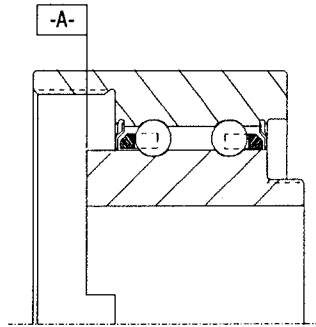

**FINAL DESIGN**

1. Shielded, preloaded, fully integral design.
2. Operations/components affiliated with non-integral bearing fit and adhesive joints eliminated.
3. Minimal contamination risk.
4. Maximum control of surface -A- runout and moment loading rigidity.

# Special Designs

## Special Bearing Assemblies

Special bearing assemblies have been a large part of MPB capabilities for many years.

Such features as:

- Non-standard bore, OD and/or width.
- Flanges, threaded shoulders, tapped holes and notches.
- Special internal geometry—race curvature, ball size, four point contact and integral shields.
- Combination of components to form integral assemblies.

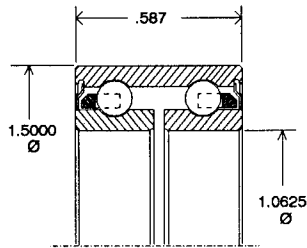

Double row outer, cartridge bearing with separated inners for external spring preloading. Used as computer disc drive actuator bearing.

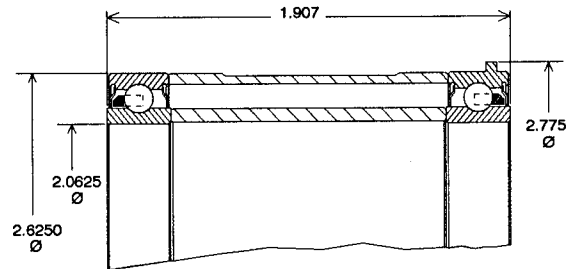

Individually double shielded, preloaded pair of bearings with special spacers and flange. For aircraft antenna support or related applications.

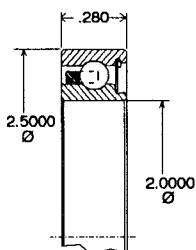

Four point contact, gothic arch, single sealed bearing with phenolic cage for controlled end play in limited space.

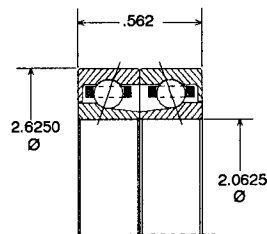

Preloaded pair of inner relieved angular contact bearings with integral shields.

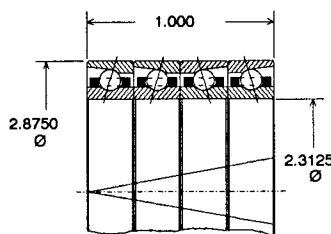

Stack of four angular contact bearings with DT/DB preload for heavy thrust load and maximum stability.

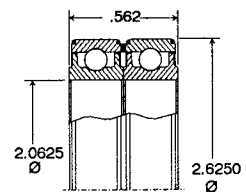

Integrally shielded, fractured outer ring, full complement bearings, DB preloaded with a special outer ring spacer.

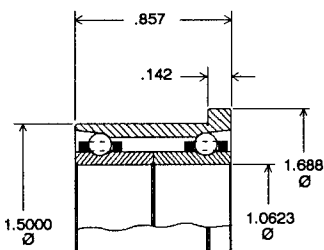

Flanged double row outer, separate inners, DB preloaded, extra wide, angular contact bearing.

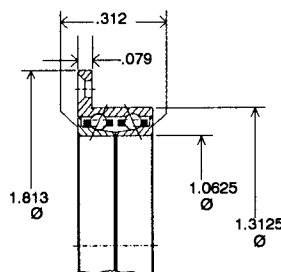

Flanged double row outer, separate inners, DB preloaded, integral shielded angular contact bearing.

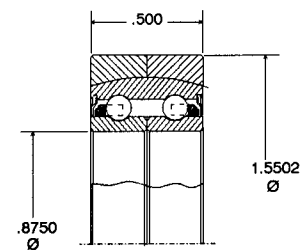

Spherically self-aligning, double row outer, separate inner, DB preloaded, double shielded bearing.

# Materials

Material selection is a critical consideration in the design of a ball bearing. Very often the interaction of the balls, races, retainer and lubricant with each other and the environment is the limiting factor in the overall performance of the bearing. MPB's extensive experience in the development and manufacture of ball bearings and bearing assemblies is a valuable resource for proper material selection.

Every component and raw material purchased by MPB is controlled by a material specification, generally exceeding industry, government and customer specifications. These specifications are constantly reviewed and updated to reflect new quality standards. Each lot of material is inspected to the material specification prior to being released to production. Bearing material requirements include hardenability, grain size, chemical analysis, and carbide and inclusion ratings. Furthermore, bearing rings and balls are checked in-process for hardness, dimensional stability and, if applicable, corrosion resistance. These quality requirements result in improved surface finish, resistance to rolling contact fatigue and improved operating characteristics.

MPB maintains an advanced heat treat department utilizing vacuum furnaces and other special equipment. Vacuum hardening allows MPB to meet the strictest military and commercial requirements for temperature uniformity along with producing a bright surface finish.

## RING AND BALL MATERIALS

**AISI 440C Stainless Steel** is a high carbon, 18% chromium steel which provides both high hardness and corrosion resistance for bearing applications. The heat treatment for the thin section bearings yields a minimum hardness of Rockwell C 58 and an operating temperature of 350°F. The heat treatment is also specifically designed to give the bearings good size stability and maintain corrosion resistance. MPB uses predominantly 440C made by the argon oxygen decarburization process for the Thin Section bearings over 2 inches in diameter. For the Thin Section product under 2 inches, MPB uses 440C made by electro-slag remelting.

**SAE 52100** is a high carbon 1 1/2% chromium steel which offers high hardness and extremely uniform microstructure. The minimum hardness required of 52100 (Rockwell C 60) is slightly higher than that of 440C, resulting in greater wear resistance. 52100 can be used at operating temperatures as high as 350°F in certain conditions. Thin Section 52100 rings are made from material manufactured by electric furnace melting followed by carbon deoxidation and vacuum degassing.

**M-50 high speed steel** contains 4 1/2% molybdenum, 4% chromium, and 1% vanadium. This material has proven particularly suited to main shaft bearings in gas turbine engines, however, it solves many other application problems as well. M50 has much greater wear resistance than both 440C and 52100 and can operate at temperatures as high as 600°F. All M50 used at MPB is made by vacuum induction melting followed by consumable electrode vacuum arc remelting (VIMVAR).

Double vacuum melting achieves the highest degree of cleanliness and uniformity of structure for this material.

**Beryllium copper** is a 2% beryllium precipitation hardening alloy used in applications where non-magnetic and electrical conductivity properties are required. It has far less hardness (Rockwell C 38 minimum), wear resistance, and strength than conventional bearing materials; therefore, the load ratings are lower.

## RETAINER, SHIELD AND SEAL MATERIALS

The physical characteristics of the retainer material are very critical to the overall performance of the bearing. There are several different materials used for Thin Section bearing retainers, each carefully selected for a particular design. A more detailed description of retainer types and material is included in the "Retainer" section of this catalog.

Standard Thin Section and Torque Tube bearing shields and seals are made from Buna-N molded rubber seals which can be used to 225°F. Viton is specified for higher temperature applications up to 400°F.

Stainless steel shields and shield retaining wires are made from AISI 300 series for maximum corrosion resistance. In non-magnetic bearings, beryllium copper is used.

## NEW MATERIALS

MPB has a group of materials engineers and technicians specifically devoted to the research and development of new bearing materials and surface treatments to enhance performance and life. In particular, MPB is a leader in the development of all-ceramic and ceramic hybrid bearings, CVD coated balls and other special surface treatments. These advanced material approaches can solve such application problems as excessive adhesive or fretting wear, performance in high temperature, vacuum, or corrosive environments, non-magnetic requirement, and high speed operation. In addition, MPB has active development programs investigating powdered metal stainless and tool steels, cobalt alloys and high temperature stainless steel. MPB's laboratory is equipped to do extensive material evaluations and bearing testing under simulated conditions.

## RING MARKING

Certain radial lines may be present on one bearing face, indicating that the bearing was made by MPB and identifying the material. These identifying marks are shown below.

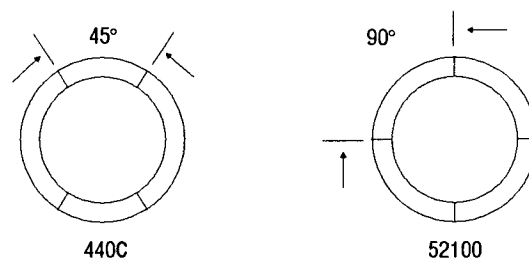

# Retainers

The correct choice of retainer for a Thin Section bearing is often critical to assuring bearing performance sufficient for application requirements.

Aside from its obvious function as a ball separator, the retainer contributes vitally to overall bearing performance and will in part determine a bearing's:





- Maximum rotational speed (dN).
- Torque characteristics.
- Temperature limits.
- Lubricant system.

As application needs dictate, MPB is prepared to offer specially configured retainers, fabricated from materials with unique properties and capabilities. A few examples are:

- High strength steel, silver plated.
- Filled TFE, sacrificial, dry film lubricant.
- Polyimide, through-porous for high oil retention.

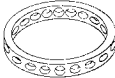
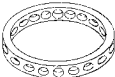
The MPB Product Engineering staff recommends and offers their assistance in retainer selection whenever there are questions as to applicability.

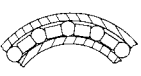
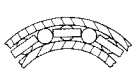
## Thin Section Retainers

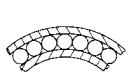
Bearing Type	Retainer Type Code	Material	Design	Description	Useful Features*	Limitations**
Angular Contact or Fractured Race	M	Phenolic Laminate		Angular Contact outer race relieved and fractured outer race, non-separable bearings with one-piece machined retainer.	Can be vacuum impregnated with oil for long life. Assembly has maximum ball complement. Speeds to 750,000 dN.	Ambient temperature to 275°F. Unidirectional thrust load with Angular Contact. Not recommended for low speed torque.
Angular Contact or Fractured Race	MT	Aluminum Bronze		Angular Contact outer race relieved and fractured outer race, non-separable bearings with one-piece machined retainer.	Highest strength. High temperature capability to 500°F. Speeds to 1,000,000 dN.	Unidirectional thrust load with Angular Contact. Not recommended for low speed torque.
Deep Groove Only	MC	Phenolic Laminate		Balls in deep groove bearing separated by a one-piece snap-in machined retainer.	Can be vacuum impregnated with oil for long life. Accepts thrust loads in both directions. speeds to 500,000 dN.	Ambient temperature to 275°F. Not recommended for low speed torque.
Deep Groove Only	MCK	Minapar II®		Balls in deep groove bearing separated by a one-piece snap-in molded retainer.	Low friction torque at speeds to 500,000 dN. Accepts thrust loads in both directions. Low cost.	Ambient temperature to 275°F. Not recommended for low speed torque.
All Types	ST	Teflon		Balls in bearing separated by individual plastic tubing slugs.	Very low breakaway frictional torque. Accepts thrust load in both directions. Speeds to 10,000 dN. Cryogenic to 500°F.	Lower load capacity than SO design.
Angular Contact or Fractured Race	SO	Teflon		Balls in bearing are separated by plastic toroids which encircle every other ball.	Very low breakaway friction. Speeds to 10,000 dN. Cryogenic to 500°F.	Unidirectional thrust load with Angular Contact.
Angular Contact or Fractured Race	S	430 SST		Balls are separated by a one-piece, stamped-thru pocketed retainer.	Low cost retainer can operate at temperatures to 600°F. Speeds to 200,000 dN.	Unidirectional thrust load with Angular Contact. Not recommended for low speed torque.
Angular Contact or Fractured Race	—	Full Ball Complement		Bearing has full ball complement assembled with fractured outer races or angular contact, relieved outer rings. No ball separator.	High radial load capacity and radial stiffness available in fractured design. Speeds to 150,000 dN.	Little thrust load capacity. High torque due to ball rubbing. Ambient to 350°F.

\* dN = Bearing ID (mm) X RPM of inner ring. (In some cases, higher values are possible given circulating oil or oil mist lubrication.)

\*\*temperatures given are limits for the retainer material only.

# Shields and Seals

Some applications may not allow the use of open bearings. Shields may be used to help retain lubricant and protect against light contamination. Light contact seals may be used in instrument or industrial applications requiring exposure to severe contamination.

The standard shield for MPB Thin Section and Torque Tube Conrad bearings is a Buna-N (nitrile) rubber molded lip shield (Figure 1). This design incorporates a stainless steel insert which is precisely located within the retention groove of the outer race, and is held in place by the compression of the rubber bead. The bead prevents lubricant bleeding at the outer race during high speed operation, even with outer race rotation. The bore of the rubber molding is trimmed to be concentric with the OD and provide a close clearance at the inner ring land. Another shield configuration which is available for selected sizes is a stainless steel shield held in place by a retaining wire (Figure 2). This shield can be used in applications where the Buna-N shield would not be suitable due to temperature or environmental limitations. Both configurations provide good protection against gross contamination and have little or no effect on frictional torque levels. Because the shields do not contact the inner land, shields would not be suitable in applications where fine (< .002") contamination is present.

In applications with fine contaminants, a seal provides the greatest protection. However, because the seal must make contact with the inner land, the frictional torque level can be up to

ten times higher than that for an open or shielded bearing.

The standard seal design for MPB's Thin Section and Torque Tube bearings is similar to the standard shield, except that the bore of the rubber molding is controlled to cause positive contact with the inner ring. The inner ring land is modified to provide an angled sealing surface (Figure 3). Buna-N rubber is the standard rubber compound for both the shields and seals. Other high temperature rubber compounds, such as Viton, can be supplied for seals requiring greater resistance to heat or chemicals.

Fractured race bearings cannot use standard shields or seals due to the thin cross-sectional area between the shield recess and the holding wire recess. A special, integral shield machined as part of the inner ring eliminates the problem for such bearings (Figure 4). Integral shields can be supplied on both equal width and extended inner ring versions.

This type of shield would have little or no effect on frictional torque due to clearance between the shield OD and outer land. The integral shield clearance effectively blocks external contamination larger than .005".

In addition to these standard shields and seals, special designs have been developed by MPB for demanding applications where a standard configuration would not suffice. Consult MPB Product Engineering for more information.

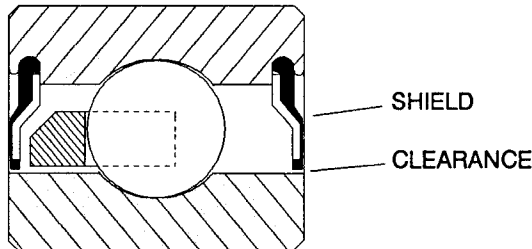

Figure 1

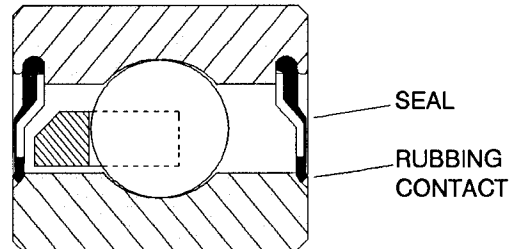

Figure 3

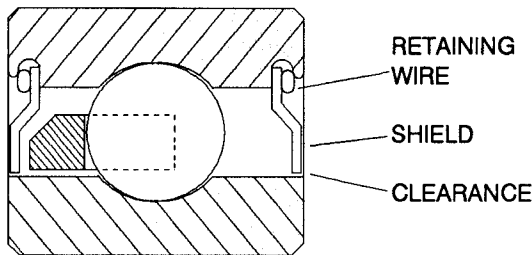

Figure 2

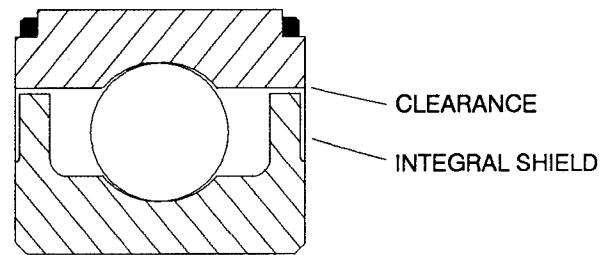

Figure 4



# Radial Play, End Play and Contact Angle

The radial play value in a specific ball bearing application is an important design consideration. Radial play or diametral clearance is the total theoretical radial movement of the outer ring with respect to the inner ring when the inner ring is fixed. Radial play is specified independently of quality or ABEC tolerance class. Ball bearings are assembled to radial play values depending upon where and how the bearing is used.

Radial play directly affects the operating contact angle and free axial or end play in a ball bearing. The axial play or end play is the total axial movement of the inner ring with respect to the fixed outer ring under a reversing axial gage load. The end play depends on the radial play, track curvatures and ball diameter. The following formula shows the relationship between these parameters:

$$P_E = \sqrt{4Bd P_R - P_R^2}$$

where:  $P_E$  = End Play  
 $B$  = Curvature Function  
 $d$  = Ball Diameter  
 $P_R$  = Radial Play

The curvature function ( $B$ ) is .08 for Thin Section bearings under 2.00" OD, and .05 for all Torque Tubes and remaining Thin Section bearings.

When bearing endplay is removed by shimming or axially loading a bearing, a line through the ball-to-race contact points forms an angle with a line perpendicular to the bearing axis. This angle is the bearing contact angle (Figure 5). The contact angle affects the amount of deflection and stress level within axially loaded bearings.

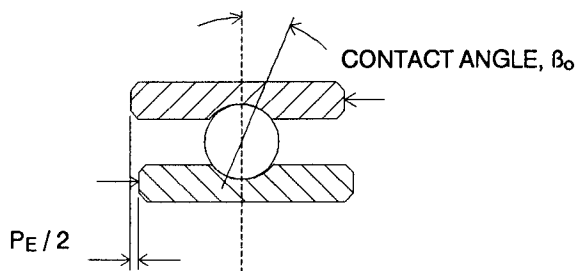

Figure 5

The contact angle is also related to radial play, ball size, raceway curvature and applied load. This relationship for bearings under no load is:

$$\cos \beta_0 = 1 - \frac{P_R}{2Bd}$$

where:  $\beta_0$  = Initial Contact Angle  
 $P_R$  = Radial Play  
 $B$  = Curvature Function  
 $d$  = Ball Diameter

The contact angle is normally controlled indirectly by a radial play specification. In some applications that require closely controlled bearing deflections, the contact angle may be specified and measured directly. For larger Thin Section bearings (4" OD and above) a standard contact angle is normally specified due to the difficulty in measuring their radial play.

## RELATIONSHIP BETWEEN RADIAL PLAY, END PLAY AND CONTACT ANGLE

Figures 6 and 7 permit designers to calculate the approximate relationship between radial play, and contact angle and end play for bearings having standard inner and outer race curvatures. Since curvature significantly effects this relationship, any bearing with special curvatures will have a different relationship. The values obtained are averages and should not be interpreted as acceptance or manufacturing limits. The end play values are not applicable to single angular contact bearings. These graphs may be used to determine the required internal clearance range from a predetermined end play or contact angle value.

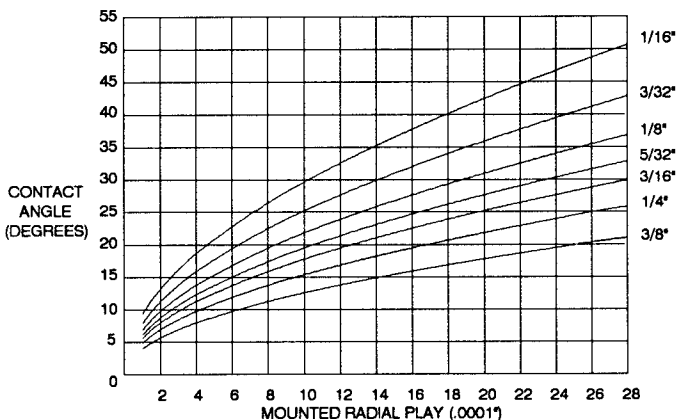

Figure 6: Contact Angle vs. Radial Play

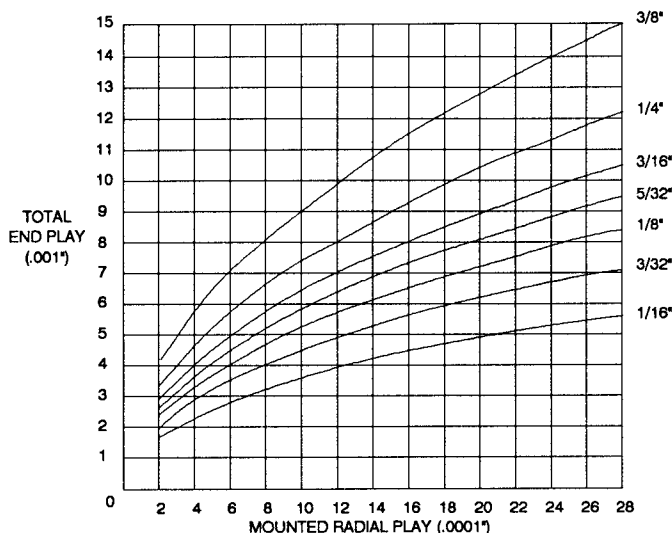

Figure 7: End Play vs. Radial Play

# Radial Play, End Play and Contact Angle (CONT.)

## RADIAL PLAY SELECTION

The standard radial play or contact angle values for the different bearing sizes and types are shown in Table 1. These values are considered optimum for most applications.

Specify a looser radial play to:

- Allow for a press fit on one or more races (approx. 80% of an interference fit is reflected in loss of radial play or reduction in contact angle).
- Provide higher contact angles under thrust loads to reduce stress levels and bearing torque.
- Provide greater axial rigidity in preloaded pairs.
- Allow for greater static and dynamic misalignment.

Specify tighter radial play to:

- Control cocking or end play when a preloaded pair is impractical.
- Control radial motion of a single bearing.

Bearing Description	Ball Size	Standard Radial Play (inches)
Conrad	1/16", 3/32"	.0003 – .0008
Conrad – ABEC 5T-7T (up to 4962 size)	1/8" 5/32" 3/16"	.0005 – .0011 .0006 – .0012 .0007 – .0015
Conrad – Class 1 & 3 Conrad (5664 and over)	1/8" and larger All	.0005 – .0015 Contact Angle 18° Nominal
Angular Contact	1/16", 3/32"	.0003 – .0008
Angular Contact (up to 4962 size)	1/8" and larger	.0007 – .0012
Angular Contact (5664 and over)	All	Contact Angle 25° Nominal
Fractured Race	1/16", 3/32"	.0003 – .0008
Fractured Race	1/8" and larger	.0005 – .0015

Table 1: Radial Play

## Tolerances

MPB manufactures Thin Section bearings in 3 standard precision grades.

The two highest grades, ABEC 7T and 5T, are in exact accordance with AFBMA\* standards where applicable. The races are specially finished to provide the ultimate in smooth running operation. These grades should be chosen for applications where the highest level of performance is required.

The Class 3 grade bearings are intended for use in less precise applications where performance characteristics such as low torque and noise normally associated with ABEC 5T and 7T are not required.

The 610 and 812 sizes listed at the beginning of each section are still controlled by ABEC 5P and 7P of AFBMA even though dimensionally they are classified as Thin Section bearings.

**Diameter Tolerance:** The significant difference between ABEC 5P and 7P and ABEC 5T and 7T is the greater tolerance allowed for out-of-roundness for the Thin Section bearings. AFBMA recognizes the difficulty of manufacturing these bear-

ings and has included a min./max. out-of-roundness allowance for the bore and OD. Bearings with fractured outer races require an additional out-of-round allowance as the chart on page 19 shows. This out-of-round condition is not detrimental to bearing performance as the raceways will conform to the roundness of the housing or shaft when mounted.

**Gaging and Inspection:** Gaging Thin Section bearings requires extreme care and special equipment to insure accurate readings. Air gaging is used to measure all critical dimensions since contact gages can actually deflect the part. If reference measurements are taken, two gram maximum gaging pressure or air gaging should be used. The actual mean diameter for mounting and calibration purposes is the average of the high and low reading if using a 2-point gage. On more critical applications, the average size may be determined more accurately by using more than two readings.

**Special Tolerance Requirements:** Specific tolerance controls for certain dimensions can be maintained for the more critical applications on a special order basis. Please consult MPB Product Engineering for assistance.

\* AFBMA—Anti-Friction Bearing Manufacturers Association

# Tolerances

## Tolerance Data

ABEC CLASS	TOLERANCES ARE IN .0001 INCHES  BASIC SIZE	INNER RING							WIDTH *	OUTER RING										
		BORE DIAMETER			RADIAL RUNOUT	FACE PARALLELISM	BORE RUNOUT WITH REF. SIDE	GROOVE RUNOUT TO REF. SIDE		OUTSIDE DIAMETER			RADIAL RUNOUT	FACE PARALLELISM	O.D. RUNOUT WITH REF. SIDE	GROOVE RUNOUT TO REF. SIDE				
		TOLERANCE	MAX. READING	MIN. READING						MEAN TOL. +0	MAX. READING	MIN. READING					MAX. OUT OF ROUND IF FRACTURED			
<b>7P</b>	610, 812	+0						+00												
<b>7T</b>	1014	-2	+0	-2	+1	+1	+1	+1	-10	-2	+0	-2	+3	+1.5	+1	+1.5	+2			
	1017																			+5
	1216	+1	-3	+1.5	+1.5	+1.5	+3													
	1219, 1421, 1724	+0.5	-2.5	+2	+6															
	1418, 1721	+1	-3	+2	-4	-														
	2024, 2226, 2428, 2430, 2630	+2	-4	+1	-3	+6	+1.5													
	2128	+1	-3	-3	-4	-														
	2532	+0		-4	+2	+1.5	+2	+2												
	2936, 3342, 3746, 3240	-3																		
	3242, 4048, 4050																			
4152, 4556, 4962, 4856, 4858		+1.5	-4.5							-4	+1	-5	+8	+3	+2	+2	+3			
5664, 5666, 6472							+2													
<b>5P</b>	610, 812	+0						+00												
<b>5T</b>	1014	-2	+0	-2	+1.5	+2	+3	+3	-10	-2	+0	-2	+4	+2	+2	+3	+3			
	1017																			+1
	1216	+2	-4	+4																
	1219	+1	-3	-4	+7	+3														
	1418, 1721	+2	-4	+3	-7	-														
	1421, 1724	+1	-3	+1	-5	+7														
	2024, 2226, 2428, 2430, 2630	+0							+00											
	2128	-3	+3	-6	+3	+3	-7	-	-50	+3	-7	-	+7							+4
	2532		+1	-4				+8		+1	-5	+7	+8							
	2936, 3342, 3746, 3240	+0																		
3242, 4048, 4050	-4		-5	+4	+3	+4														
4152, 4556, 4962, 4856		+2	-6						-5	+2	-7	+9	+4	+3					+5	
4858, 5664, 5666, 6472																				
<b>CLASS 3</b>	610, 812, 1014, 1017, 1216	±2	+3	-3	+4	+3	+4	+5	+00	-4	+1	-5	+8	+4	+3	+4	+5			
	1219, 1421, 1724																			-5
	2128	±3	+4	-4	+5	+3				-6		-7	+9	+6						
	2532, 2936																			
	3240, 3242	+2																		
	3342, 3746, 4048, 4050																			
	4152, 4556, 4962										+0		-9	+10	+8	+5	+5	+7		
	4856, 4858																			
5664, 5666, 6472	+3																			
	-5																			

\* Total Width Tolerance for Duplex Pairs: +.000", -.015"

# Lubrication

A lubricant may be visualized as a separating layer between two sliding surfaces, the purpose of which is to inhibit surface wear while maintaining the lowest possible frictional torque level. The ball and raceway surfaces, although precision honed, appear microscopically as a pattern of "hills and valleys." When rubbed together under the high unit loading inherent in point contacts, these asperities can weld together, then break off, initiating an adhesive wear process which ultimately fails the bearing. Adhesive wear is inhibited by:

- Elastohydrodynamic (EHD) film.
- Boundary lubrication.
- Mixed film lubrication.

**EHD films** are generated dynamically in a rotating bearing, depending on the lubricating fluid's property of increasing viscosity with increasing pressure. Ball-to-race contacts can be effectively separated by the high viscosities generated under typical pressures expressed in hundreds of thousands of pounds per square inch. Once separated by a distance greater than asperity height, the surfaces will not contact and adhesive wear will be eliminated. In practical terms, EHD film depends primarily on:

- Fluid viscosity at operating temperature.
- Bearing speed.

**Boundary lubricating films** are formed on machined steel surfaces as chemically absorbed compounds resulting from the surface's interaction with its environment. Preferred films may be formed by chemical treatment of the surface as it is processed and by additives in the lubricating fluid.

**Mixed film lubrication**, a combination of EHD film and boundary conditions, describes the regime in which most instrument ball bearing contacting surfaces operate.

## LUBRICANT SELECTION

Fluids used as bearing lubricants are effective as they reflect these film generating properties:

- High pressure/viscosity coefficient.
- Viscosity (at operating temperatures) compatible with adequate EHD film generation.
- Additives providing preferred absorbed films.

Further consideration must be given to the fluid properties relating to other application parameters:

- Temperature capability.
- Volatility.
- Viscosity-temperature.
- Surface tension (migration).
- Oxidation stability.
- Corrosion inhibition.

Fluids used as lubricants are generally mineral or synthetic oils, formulated with anti-oxidation and anti-wear additives, and offered commercially.

Greases are oils, thickened with metallic soaps, clay, urea or other material, to maintain their position within the bearing cavity, assuring a supply of fluid over an extended time.

Oils are used where low bearing friction torque is a primary consideration, although grease may provide longer operating life and better resist lubricant loss due to "spin-out" at higher speeds. EHD film criteria should be applied to grease base-oils in the same manner as applied to oils. However, the vast difference in properties of various grease thickeners makes their selection somewhat more complex than oils.

Military specifications describe various classes of lubricants, both oils and greases, and usually relate to specific bulk properties rather than to specific formulation. For this reason, and due to the large number of proprietary formulations on the market, care should be taken to fully evaluate specific trade-name lubricant products in application.

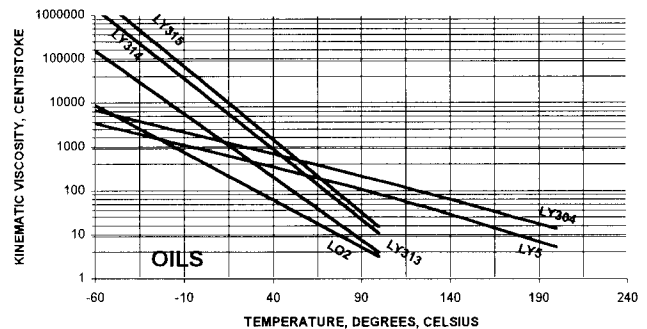

Figure 8: Kinematic Viscosity Temperature Curve—Oils

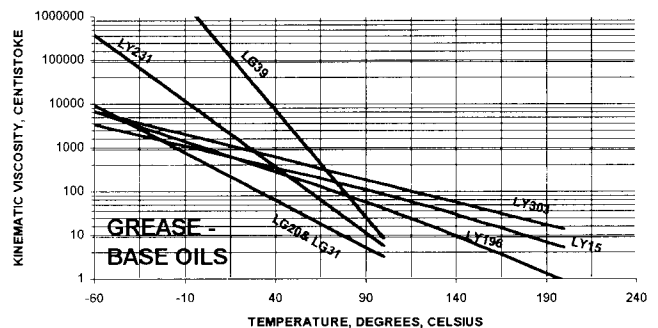

Figure 9: Kinematic Viscosity Temperature Curve—Base Oils

# Lubrication

## LUBRICATING METHODS

Instrument ball bearings, with few exceptions, are prelubricated and receive no further lubrication during their operating life. Applications often depend on the maintenance of very low bearing friction torque for proper function which, in turn, is influenced by lubricant quantity and placement. MPB has developed a number of techniques for control of lubricant quantity and placement to allow use of the bearing directly out of the package.

## OILING METHODS

**Dip and Drain:** Slight excess of oil on all bearing surfaces, providing corrosion protection as well as final lubrication; specify as LO or LY.

**Dip and Centrifuge:** Oil on all surfaces with quantity controlled by specified centrifuge level. Specify as LOC or LYC plus "G" level.

**Vacuum Impregnate:** Bearings with porous ball retainers are immersed in oil while under vacuum, followed by soak at room

pressure, thereby forcing oil into retainer pores. Specify as LOV or LYV.

## GREASING METHODS

**Standard Greasing:** Meter controlled quantity of grease directly into bearing cavity. Specify as LG or LY, plus quantity in % fill or milligrams.

**Film Greasing:** Apply grease-solvent mixture to bearing cavity to achieve controlled quantity. Specify as LGF or LYF, plus quantity in milligrams.

## SPECIAL LUBRICATION

The vast majority of instrument ball bearing applications are adequately lubricated by conventional oils and greases. In certain environments this is not possible, usually because of high or low temperatures, high vacuums or other limitations on use of fluids. Various types of solid film coatings may be considered for these applications, although, in general, bearing performance and life expectancy must be down rated severely.

## Commonly Used Bearing Lubricants

MPB Code	Lubricant	Oil Type	Thickener	Oil Viscosity Centistokes		Temp Range (°F)	Mil-Spec
				100°F	210°F		
<b>OILS</b>							
L02	Anderol L401D	Diester	–	12.7	3.4	-65 to 200	MIL-L-6085
LY313	Minapure M018	Synthetic Hydrocarbon	–	18.0	3.7	-80 to 300	MIS-35841
LY314	Minapure M075	Synthetic Hydrocarbon	–	75.0	10.9	-65 to 300	MIL-L-53131
LY315	Minapure M0119	Synthetic Hydrocarbon	–	119.0	15.4	-60 to 300	MIL-L-53131
LY5	NYOSIL M20	Silicone	–	52.0	16.0	-100 to 450	MIL-S-81087 (Type I)
LY303	Bray 815Z	Fluoroether	–	150	45	-112 to 392	–
<b>GREASES</b>							
LG20	Beacon 325	Diester	Lithium Soap	13.2	3.3	-65 to 250	–
LG31	Minapure Grease	Diester	Lithium soap	12.5	3.3	-65 to 250	MIL-G-81937
LG39	Andok C	Petroleum	Sodium Soap	110.0	8.5	-20 to 250	–
LY15	NYOGEL 7810	Silicone	Lithium Soap	52.0	16.0	-100 to 450	–
LY231	Mobil 28	Synthetic Hydrocarbon	Clay	30.0	5.7	-65 to 300	MIL-G-81322
LY304	Braycote 601EF	Fluoroether	PTFE	150	45	-112 to 400	–
LY196	Aeroshell 7	Diester	Microgel	3.1	14.7	-100 to 300	MIL-G-23827

# Coding for Shaft and Housing Fits

The bearings fabricated at MPB are manufactured to precise tolerances and geometries. In order to ensure this precision is maintained in the application, the geometry and tolerances of the shaft OD, housing bore and adjacent shoulders must be consistent with those of the bearing's mating surfaces.

The thin cross-sectional area and large diameter of this bearing series will cause the inner and outer rings to conform to the shaft or housing when mounted. Therefore the roundness of the mounting surface should be held within the radial runout noted on page 19 for the ring being mounted. The size tolerances of the mounting surfaces should be the same as that of the bearing ring being mounted. The surface finish of the mounting surface should be 12AA or better.

Interference fits should be evaluated carefully as the thin section of the bearing rings will cause a reduction in the radial play of approximately 80% of the interference fit. This is especially important in factory preloaded duplex pairs as the interference fit will cause an increase in preload.

In cases where selective assembly is necessary to eliminate extreme fits, the bores and outside diameters of the bearings may be coded and matched with similarly graded shaft and housing diameters.

Codes are measured .0001" increments and are supplied randomly with the specific code of the bore and/or OD marked on

Tolerance	.0001" Increment Coding (Standard)	.000050" Increment Coding	Half Tolerance Coding
Nominal to -.000050"	1	A	H
-.000050" to -.000100"		B	
-.000100" to -.000150"	2	C	L
-.000150" to -.000200"		D	
-.000200" to -.000250"	3	E	L
-.000250" to -.000300"		F	
<b>Grade Symbols</b>			
Graded Bore and O.D.	ZD	XZD	HZD
Graded Bore Only	ZB	XZB	HZB
Graded O.D. Only	ZO	XZO	HZO
Graded Bore and O.D. Matched for Preloaded Pairs	ZDM	XZDM	HZDM

Table 2: Bore and OD Coding

the package label. In special situations, specific codes can be supplied, and coding may be performed in .000050" increments.

The codes for thin section bearings are determined by averaging several two-point diameter readings. The bore code is the average size of the two point diameter measurements taken at the minimum size due to taper. The OD code is the average of the diameter readings taken at maximum size due to taper. Because of the thin cross section of the rings minimal gage pressure is used to prevent distortion of the ring. For this reason MPB does not recommend that reinspection of the bore and OD to confirm codes be performed at the customer's facility.

When preloaded bearing pairs are required to be coded and matched, the following criteria apply. The ZDM code requires that the bore and OD codes be selected to be the same size within the increment indicated. It is not necessary that they be of the same code symbol. The code symbol of the pair will be that of the smaller bore and the larger OD of the pair.

To avoid confusion between digits or letters and symbols, hyphens are used before bore and/or OD codes. The bore code is the first digit.

**EXAMPLES**

ZD-1-2 = Bore nominal to -.000100"  
OD -.000100" to -.000200"

HZB-L = Bore size in lower half of bore tolerance

ZDM-2-1 = Both bores of pair are equal size within .000100".  
The smaller is from -.000100" to .000200".  
Both OD's of pair are equal size within .000100".

When shaft and housing materials have coefficients of expansion which differ from that of the bearing material, the fits due to the temperature extremes should be carefully examined. Figure 10 can be used to help evaluate these fits.

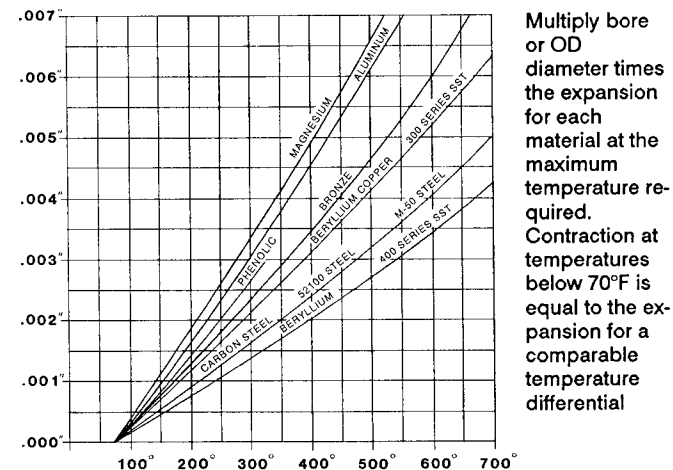

Multiply bore or OD diameter times the expansion for each material at the maximum temperature required. Contraction at temperatures below 70°F is equal to the expansion for a comparable temperature differential

Figure 10: Coefficients of Expansion

# Load Ratings

Load ratings are calculated to provide a guide for bearing selection against application requirements. They are not absolute and variations in calculation methods exist within the industry that make direct comparison between manufacturers' catalog values impractical. Load ratings in this catalog are calculated for bearing steels using the mean of the standard radial play range or in the case of angular contact bearings, the nominal contact angle tabulated.

## DYNAMIC LOAD RATING

Bearing life may be defined as the length of time a bearing will operate satisfactorily in the application at its operating speed under an applied load. Life predictions depend on careful definition of failure criteria and consideration of operating environment, mounting practice, lubrication, possible contamination, geometry control, operating speed and, of course, loading.

The expected fatigue life under operating loads is seldom the most important design consideration in the selection of instrument ball bearings. The dynamic load rating figures are presented primarily to permit a comparison of the load carrying potential for bearings of similar material but differing in size, internal design and ball complement.

Life predictions are necessarily nonprecise because of the interaction of these many parameters. The AFBMA has established an accepted method of calculating fatigue life, outlined in AFBMA Standards. The AFBMA Rating Life ( $L$ ) is the number of revolutions, or hours at constant speed, that 90% of a group of apparently identical bearings will attain, or exceed, before the first evidence of fatigue develops. The dynamic load rating ( $C$ ) is the constant radial load, stationary with respect to the outer ring, that a bearing can endure for a rating life of one million revolutions of the inner ring, or 500 hours at 33 1/3 rpm. The dynamic load rating is determined by bearing geometry, number and size of balls, bearing pitch diameter, and ring and ball material. The dynamic load rating ( $C$ ) for each bearing is shown in the tabulations in the body of the catalog.

This load rating is used in conjunction with the actual applied radial load ( $R$ ) to calculate bearing fatigue life as follows:

$$L_H = \frac{16667}{N} (C / R)^3$$

where:  $L_H$  = Rating Life in Hours  
 $N$  = Speed of Inner Ring Rotation, in RPM  
 $C$  = Dynamic Load Rating  
 $R$  = Applied Pure Radial Load, in lbs.

The rating life as defined above relates solely to metal fatigue and assumes perfect bearing configuration, alignment, lubrication and cleanliness. In addition, these load ratings and life calculations are based on the application of a pure radial load. Note

that the dynamic load rating value is used only in life calculations and, for instrument bearing applications, should not be approached in actual applied load. MPB can assist in establishing fatigue life calculations for combination thrust and radial loads, pure thrust loads, outer ring rotation, preloaded bearing pairs or probabilities other than 90%.

## STATIC LOAD RATINGS

As load is applied to a nonrotating bearing a value will be reached beyond which permanent deformation of raceways and balls occurs. The resulting indentations, or 'brinells', become defects interfering with smooth operation and shortening bearing life. Static load ratings relate to limiting loads applied to non-rotating bearings, as in bearing mounting, or to shock loads applied to rotating bearings. Operating loads should not approach the rated value except in isolated cases.

AFBMA standards state that static load ratings depend on the maximum contact stress between the balls and either of the two raceways. It is affected by material, number and size of balls, raceway curvatures, raceway depths and contact angle.

A maximum contact stress level of 580,000 PSI has been established as a satisfactory limit for most applications and is the basis for static load ratings tabulated herein.

Where low vibration and frictional torque levels are of primary concern, applied loads should result in no more than 508,000 PSI maximum contact stress, representing an approximate 40% reduction from the tabulated static load ratings.

### Static Radial Load Ratings

The static radial load ratings ( $R_S$ ) is that pure radial load which, when applied to a non-rotating ball bearing, will result in a maximum stress level of 580,000 PSI at the most heavily loaded ball contact.

### Static Thrust Load Ratings

The static thrust load rating ( $T_S$ ) is that pure axial load which, when applied to a ball bearing, will result in:

- (a) a maximum stress level of 580,000 PSI and or
- (b) a ball-raceway contact area which lies completely within the raceway (i.e., the contact area is not truncated by the raceway shoulder on either ring).

### CAUTION

In the case of Fractured Race bearings, to avoid opening under normal loose fits, pure thrust loads should not exceed 90 pounds. If the outer race is fitted line-to-line or tight, thrust loads equivalent to the  $T_S$  values listed for the Angular Contact series on pages 6 and 7 may be applied.

# Preload/Deflection/Torque

## PRELOAD

There are several basic reasons for preloading a ball bearing set:

- To remove radial and axial play for more precise shaft positioning.
- To control the axial and radial stiffness (compliance) of the system.
- To maintain ball-race contact to prevent skidding and reduce noise.
- To improve load sharing between bearings.

The typical preload configurations are shown below.

### Preloading Thin Section Bearings

Thin Section bearings have relatively low compliance levels; when preloaded they are very stiff. Because of this characteristic, the preload tolerance should be at least half the minimum preload level specified or 2 lbs., whichever is greater. For a Torque Tube bearing, the preload tolerance should be at least half the minimum preload level specified or 4 lbs., whichever is greater.

Low preload levels are difficult to consistently and accurately measure. A narrow preload tolerance is difficult to achieve consistently as the deflection difference between the minimum and maximum preload values approaches the repeatability of the measuring equipment.

### DEFLECTION (COMPLIANCE)

Under applied loads, balls and raceways will deflect elastically up to the yield point of the material. This limit is approximated by the static load capacity ratings ( $R_s$  and  $T_s$ ) shown for each bearing on pages 4-9, and 28-32.

The larger number of small diameter balls in a Thin Section bearing brings more area into contact and, under thrust load, allows for a more rapid increase in contact angle and resultant reduced deflection as compared to a heavy section bearing with equivalent bore diameter. This is a distinct advantage in gimbal bearings where axis intersection under G loading is critical.

## TORQUE

Thin Section bearings provide lower torque levels than heavier section ball bearings, under similar operating conditions. The greater quantity of balls reduces the load per ball. This coupled with a smaller ball diameter results in a smaller ball-to-race contact ellipse generally resulting in lower torque.

For optimum low torque in slow-speed or oscillatory service, the use of oil lubrication and toroid separators is recommended; as well as the lowest preload range consistent with the application requirements.

High-speed, torque-sensitive applications are best served with one-piece machined phenolic retainers, and oil or channeling grease lubrication.

Thin Section bearings are similar to miniature and instrument bearings in that they are more sensitive to housing and shaft fits and geometry than are heavier section bearings. Deviations from true roundness in either the housing or shaft diameter can adversely affect the bearing torque.

### PRELOADED PAIR MARKING

Thin Section pairs and all DT pairs are marked with two axial lines forming a 30° included angle "V" etched across their OD's. For DT pairs, the "V" points in the direction of thrust load to the outer ring face per the example shown.

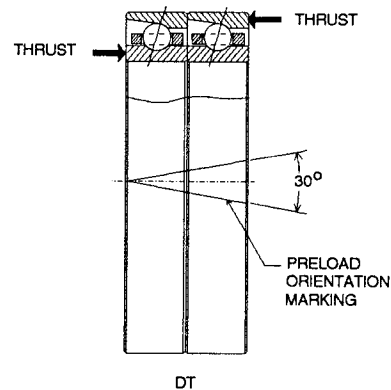

## Preload Configurations

DB (Back to Back)

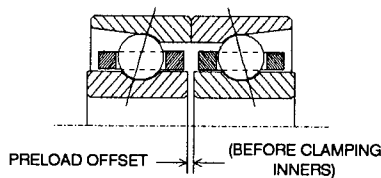

Preferred for high moment stiffness

DF (Face to Face)

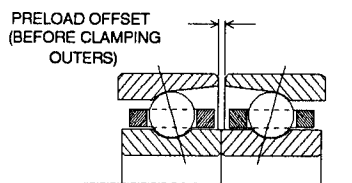

Preferred for low moment stiffness; allows for slight misalignment at low speeds

DT (Tandem)

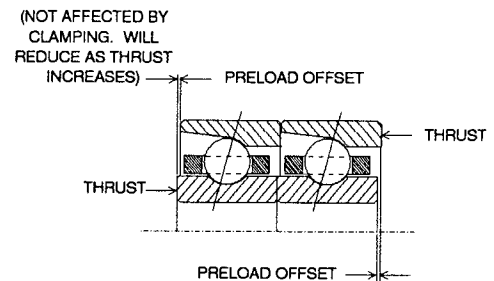

Preferred for unidirectional axial load sharing and greater axial stiffness



# Preload/Deflection/Torque

## CALCULATING DEFLECTION SPRING RATE

### Universal Axial Deflection

The curves in Figure 11 are provided for determination of axial deflection for five basic contact angles (12°, 15°, 18°, 25°, and 30°) as a function of ball size, number of balls and thrust load. From these basic curves, data can be extracted for plotting of axial deflection curves for specific sizes as single bearings and preloaded pairs. This data applies when bearings are solid mounted with line to line fits.

### Axial Deflection of Single Bearings

Single bearing axial deflection can be found from the curves in Figure 11. Example: for S4048M 7 where  $N = 52$ ,  $D = 1/8$ ,  $\beta_0 = 25^\circ$ .

- Calculate  $T/ND^2$  for several assumed values of  $T$  (thrust load) using  $N$  (number of balls) and  $D$  (ball diameter) from bearing size data.
- Enter the curve for  $\beta_0 = 25^\circ$  on Figure 11 and read out  $\delta h/D$ . Multiply by  $D$  to obtain axial deflection  $\delta h$  at  $T$ . Using these values of  $\delta h$  and  $T$ , construct a curve such as shown in Figure 12.

### Axial Deflection and Spring Rate for Preloaded Sets

Preloaded pair (DB or DF) axial deflection can be plotted as in Figure 13 using data from the single bearing curve constructed in Figure 12. Example: for S4048M 7 DB120

- Enter the curve established in Figure 12 at a thrust load equal to the preload value of 120 lbs. at points (1) and (2).
- Double the single bearing deflection of .00022 to determine point (3) .00044 and move to the right to intersect the curve again at point (4).
- Drop to the original axial deflection level at point (5) and connect this point to the origin 0.

This straight line represents the axial deflection of a preloaded pair of the example bearings.

$$\text{The spring rate} = \frac{\text{axial deflection at (5)}}{\text{thrust load at (5)}}$$

$$\text{Example: } \frac{.00022}{390} = 5.64 \times 10^{-7} \text{ inches/lb.}$$

### Radial Spring Rate

Preloaded bearing sets are usually stiffer radially than axially. The ratio of radial yield to axial yield will vary from as low as 1:6 at low contact angles and approach 1 (isoelasticity) as the contact angle nears 35°. Since the variables involve not only contact angle, but also ball size, number of balls and preload, we suggest that if an accurate value of radial spring rate is required that MPB be contacted. Product Engineers are available to provide technical assistance.

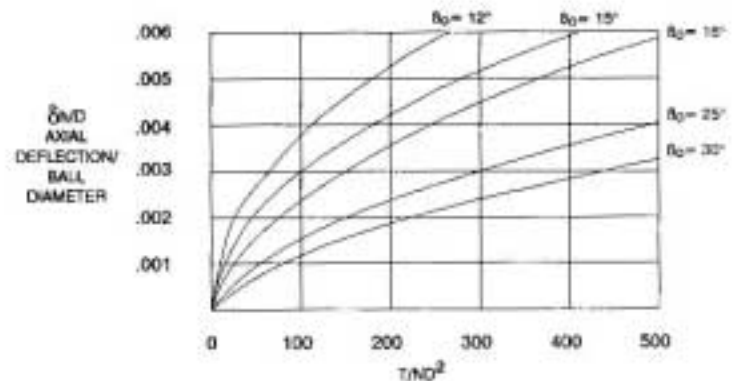

Figure 11: Axial Deflection - Universal

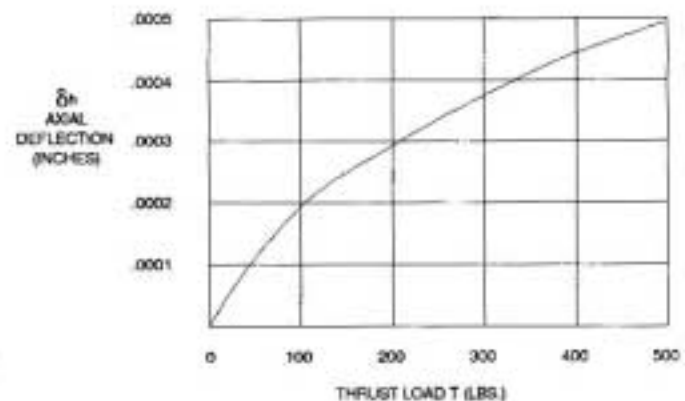

Figure 12: Axial Deflection - Single Bearing

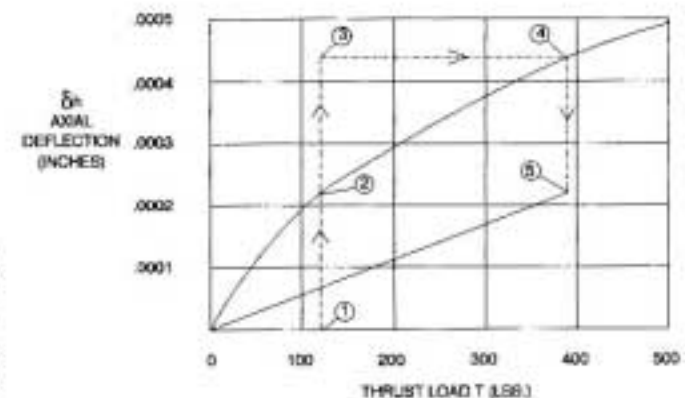

Figure 13: Preloaded Set - Axial Deflection and Spring Rate

# SBB Introduction

Large Thin Section Bearings with diameters over 6.0" are Manufactured by the SBB Division of Timken Aerospace & Super Precision Bearings. Located in Lebanon, NH, the SBB Division is a leader in large thin section bearing technology.

Dimensional and load capacity information for Thin Section bearings which are manufactured by the SBB Division of Timken Aerospace & Super Precision Bearings is provided on pages 28-31. The SBB Division part numbering system has also been maintained for this product and is explained on the following

page. In Addition, the Fractured Race Commercial Series bearings are shown on page 32.

The engineering data previously covered in this catalog is equally applicable to the SBB Division manufactured product, with the exception of tolerances which are detailed on page 33.

For additional engineering information, please contact SBB Division Product Engineering.

## Bearing Types

FOUR BASIC BEARING TYPES ARE AVAILABLE AND CHOICE SHOULD BE BASED ON THE FOLLOWING

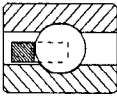
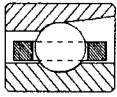
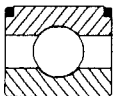
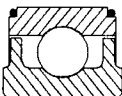
TYPE	DESIGNATION	GENERAL DESCRIPTION
<b>CONRAD</b> 	<b>3TK</b> —Equal width races <b>3TKC</b> —Extended inner race	Conventional Conrad design for general purpose use. Best for average speed and moderate loads in any direction. Limited in retainer selection and strength where operating conditions are demanding. Available with removable seals and shields.
<b>ANGULAR CONTACT</b> 	<b>3TA</b> —Equal width races <b>3TAC</b> —Extended inner race	Angular Contact bearings provide highest thrust capacity in one direction. Ideal for preloaded pairs in gimbals or spin positions. Require preload to develop radial capacity. Allows full flexibility in retainer selection.
<b>FRACTURED RACE OPEN</b> 	<b>TCN</b> —Equal width races <b>TC</b> —Extended inner race	The fractured outer race construction allows higher multidirectional loads and greater speeds than Conrad. Ideal for high radial loads with full ball complement or one piece retainer design. Will accommodate thrust or moment loads with special fits for outer race. Allows complete flexibility in retainer selection.
<b>FRACTURED RACE INTEGRAL SHIELD</b> 	<b>TW</b> —Extended inner race	Precision ground integral shields can not be damaged in handling or operation. Available with full or alternate ball complement and with Teflon spacers.

Please note: Fractured Race bearing designs in sizes comparable to those shown on pages 28-31 are not available as standard configurations. However, if your application might benefit from the features of this design, please contact SBB Product Engineering.

# Part Numbering

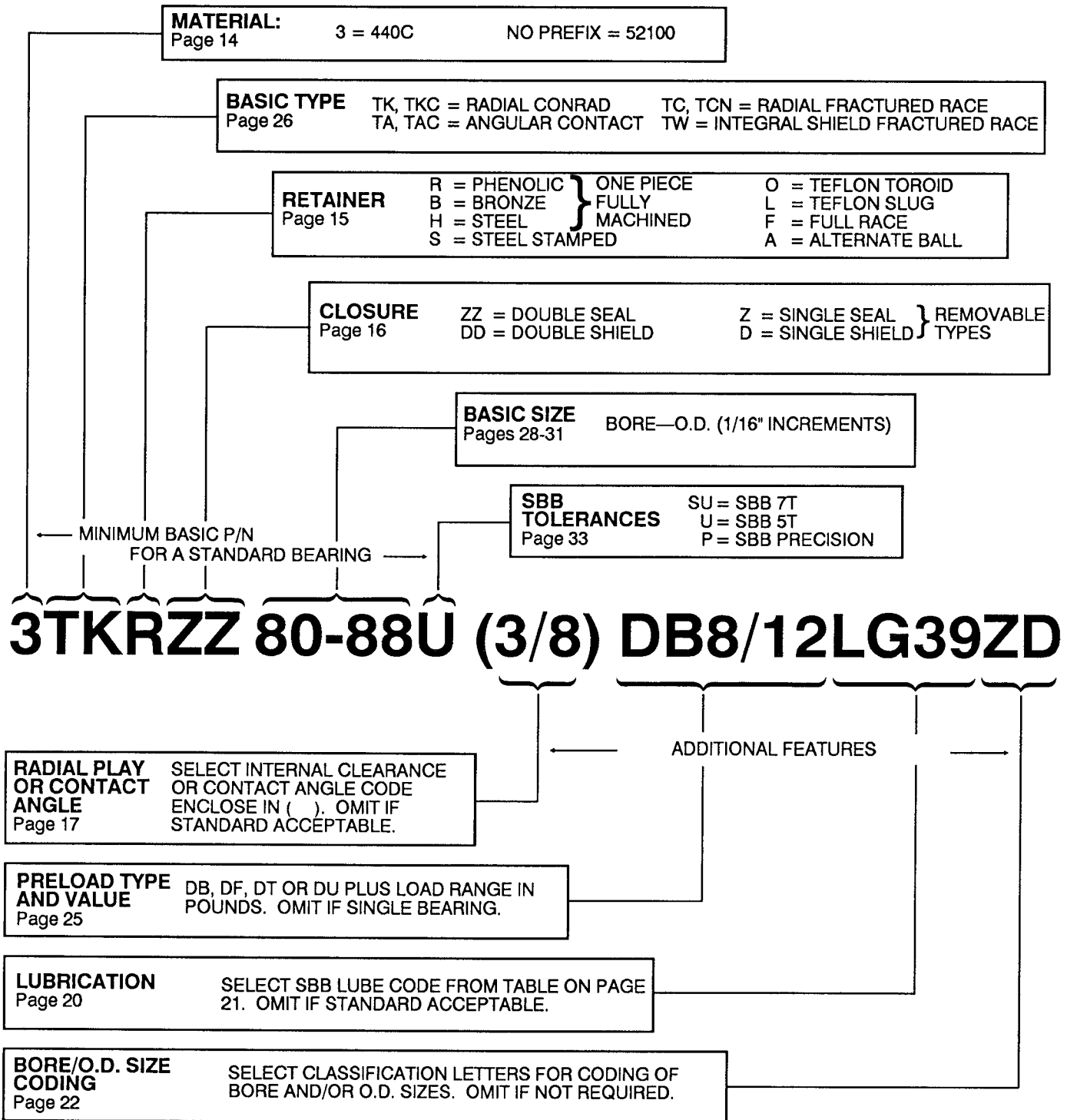

## Special Variations

For other special modifications and controls, contact your MPB Sales Engineer, forward a print or call the plant for discussion with SBB Engineers. Once defined, your special requirements will be coded in a sequential "dash number" control drawing.

**Example: 3TAR 68-84-161**

Special Sequential Dash Number

# Conrad Assembly

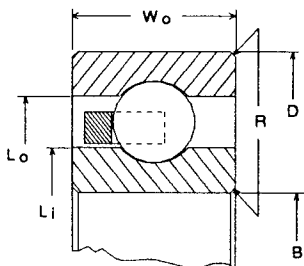

Large Thin Section Conrad Bearings are available in sizes up to 12" OD. The ball grooves are honed for precision, low torque, and quiet operation. The deep groove construction allows for handling of radial, thrust or combination loads. While offered primarily with 440C stainless steel rings and balls and with a one-piece fully machined snap-in phenolic cage, other material and separator options are available for specific application requirements.

**Example P/N: 3TKC 80-88 U**

## Large Thin Section Series

Basic Bearing Size	Bore B	O.D. D	Width W <sub>o</sub>	Land Diameter		Radius R	Ball Complement		Load Ratings (lbs.)			Approx. Weight lbs.
									Radial		Thrust	
									Dynamic	Static	Static	
									C	R <sub>s</sub>	T <sub>s</sub>	
64-74	4.000	4.625	.3125	4.219	4.406	.040	5/32	45	1885	2440	2855	.26
64-76	4.000	4.750	.375	4.263	4.488	.040	3/16	38	2451	2935	3475	.39
64-80	4.000	5.000	.500	4.350	4.650	.060	1/4	30	3777	4040	4875	.70
68-76	4.250	4.750	.250	4.425	4.575	.025	1/8	58	1378	2035	2355	.17
68-78	4.250	4.875	.3125	4.469	4.656	.040	5/32	48	1934	2600	3045	.28
68-80	4.250	5.000	.375	4.513	4.738	.040	3/16	40	2496	3100	3655	.41
68-84	4.250	5.250	.500	4.600	4.900	.060	1/4	31	3803	4195	5035	.74
72-80	4.500	5.000	.250	4.675	4.825	.025	1/8	62	1424	2180	2520	.19
72-82	4.500	5.125	.3125	4.719	4.906	.040	5/32	50	1957	2720	3175	.29
72-84	4.500	5.250	.375	4.763	4.988	.040	3/16	43	2581	3340	3930	.43
72-88	4.500	5.500	.500	4.850	5.150	.060	1/4	33	3913	4485	5360	.78
76-84	4.750	5.250	.250	4.925	5.075	.025	1/8	65	1443	2285	2640	.20
76-86	4.750	5.375	.3125	4.969	5.156	.040	5/32	53	2002	2890	3365	.31
76-88	4.750	5.500	.375	5.013	5.238	.040	3/16	45	2620	3505	4115	.45
76-92	4.750	5.750	.500	5.100	5.400	.060	1/4	35	4011	4770	5690	.82
76-100	4.750	6.250	.750	5.275	5.725	.080	3/8	25	7332	7435	9140	1.95
80-88	5.000	5.500	.250	5.175	5.325	.025	1/8	68	1469	2395	2760	.21
80-90	5.000	5.625	.3125	5.219	5.406	.040	5/32	55	2028	3000	3490	.32
80-92	5.000	5.750	.375	5.263	5.488	.040	3/16	47	2665	3670	4295	.47
80-96	5.000	6.000	.500	5.350	5.650	.060	1/4	36	4037	4930	5850	.86
80-104	5.000	6.500	.750	5.525	5.975	.080	3/8	26	7443	7770	9506	2.05
88-96	5.500	6.000	.250	5.675	5.825	.025	1/8	74	1508	2620	3010	.23
88-98	5.500	6.125	.3125	5.719	5.906	.040	5/32	60	2093	3300	3810	.35
88-100	5.500	6.250	.375	5.763	5.988	.040	3/16	51	2737	4000	4660	.52
88-104	5.500	6.500	.500	5.850	6.150	.060	1/4	39	4154	5365	6340	.94
88-112	5.500	7.000	.750	6.025	6.475	.080	3/8	28	7644	8435	10240	2.22

R = The maximum radius of shaft or housing fillet that the bearing corner will clear.  
 C = Dynamic radial capacity @ 33 1/3 RPM for 2500 hours average life (L-10 life is 500 hours).  
 R<sub>s</sub> = Static radial capacity.  
 T<sub>s</sub> = Static thrust capacity.

# Conrad Assembly

## Large Thin Section Series

Basic Bearing Size	Bore	O.D.	Width	Land Diameter		Radius	Ball Complement		Load Ratings (lbs.)			Approx. Weight lbs.
							Size	Number	Radial		Thrust	
	Dynamic	Static	Static									
	C	R <sub>s</sub>	T <sub>s</sub>									
96-104	6.000	6.500	.250	6.175	6.325	.025	1/8	80	1554	2840	3250	.25
96-106	6.000	6.625	.3125	6.219	6.406	.040	5/32	65	2152	3580	4125	.38
96-108	6.000	6.750	.375	6.263	6.488	.040	3/16	55	2815	4330	5030	.57
96-112	6.000	7.000	.500	6.350	6.650	.060	1/4	43	4329	5950	6990	1.02
96-120	6.000	7.500	.750	6.525	6.975	.080	3/8	30	7839	9100	10970	2.40
104-112	6.500	7.000	.250	6.675	6.825	.025	1/8	87	1606	3100	3535	.27
104-114	6.500	7.125	.3125	6.719	6.906	.040	5/32	70	2210	3870	4445	.41
104-116	6.500	7.250	.375	6.763	6.988	.040	3/16	59	2880	4660	5390	.61
104-120	6.500	7.500	.500	6.850	7.150	.060	1/4	46	4433	6395	7475	1.09
104-128	6.500	8.000	.750	7.025	7.475	.080	3/8	32	8028	9760	11700	2.57
112-120	7.000	7.500	.250	7.175	7.325	.025	1/8	93	1645	3320	3780	.29
112-122	7.000	7.625	.3125	7.219	7.406	.040	5/32	75	2269	4150	4760	.44
112-124	7.000	7.750	.375	7.263	7.488	.040	3/16	64	2984	5070	5850	.66
112-128	7.000	8.000	.500	7.350	7.650	.060	1/4	49	4537	6830	7960	1.17
112-136	7.000	8.500	.750	7.525	7.975	.080	3/8	34	8197	10420	12430	2.75
120-128	7.500	8.000	.250	7.675	7.825	.025	1/8	99	1677	3530	4020	.31
120-130	7.500	8.125	.3125	7.719	7.906	.040	5/32	80	2321	4450	5080	.47
120-132	7.500	8.250	.375	7.763	7.988	.040	3/16	68	3042	5400	6215	.70
120-136	7.500	8.500	.500	7.850	8.150	.060	1/4	52	4628	7265	8450	1.24
120-144	7.500	9.000	.750	8.025	8.475	.080	3/8	36	8372	11080	13160	2.92
128-136	8.000	8.500	.250	8.175	8.325	.025	1/8	106	1723	3790	4305	.33
128-138	8.000	8.625	.3125	8.219	8.406	.040	5/32	86	2392	4790	5460	.50
128-140	8.000	8.750	.375	8.263	8.488	.040	3/16	72	3107	5730	6580	.74
128-144	8.000	9.000	.500	8.350	8.650	.060	1/4	55	4719	7705	8940	1.33
128-152	8.000	9.500	.750	8.525	8.975	.080	3/8	38	8541	11735	13895	3.11
144-152	9.000	9.500	.250	9.175	9.325	.025	1/8	118	1788	4225	4795	.36
144-154	9.000	9.625	.3125	9.219	9.406	.040	5/32	96	2483	5350	6095	.57
144-156	9.000	9.750	.375	9.263	9.488	.040	3/16	80	3221	6390	7310	.83
144-160	9.000	10.000	.500	9.350	9.650	.060	1/4	62	4947	8720	10075	1.48
144-168	9.000	10.500	.750	9.525	9.975	.080	3/8	43	8990	13360	15720	3.47
160-168	10.000	10.500	.250	10.175	10.325	.025	1/8	131	1859	4700	5320	.40
160-170	10.000	10.625	.3125	10.219	10.406	.040	5/32	106	2574	5930	6730	.63
160-172	10.000	10.750	.375	10.263	10.488	.040	3/16	89	3354	7120	8135	.91
160-176	10.000	11.000	.500	10.350	10.650	.060	1/4	68	5109	9600	11050	1.64
160-184	10.000	11.500	.750	10.525	10.975	.080	3/8	47	9269	14680	17185	3.82
176-184	11.000	11.500	.250	11.175	11.325	.025	1/8	144	1924	5100	5850	.44
176-186	11.000	11.625	.3125	11.219	11.406	.040	5/32	116	2659	6490	7365	.70
176-188	11.000	11.750	.375	11.263	11.488	.040	3/16	97	3458	7780	8865	1.00
176-192	11.000	12.000	.500	11.350	11.650	.060	1/4	74	5259	10480	12025	1.79

R = The maximum radius of shaft or housing fillet that the bearing corner will clear.  
 C = Dynamic radial capacity @ 33 1/3 RPM for 2500 hours average life (L-10 life is 500 hours).  
 R<sub>s</sub> = Static radial capacity.  
 T<sub>s</sub> = Static thrust capacity.

# Angular Contact

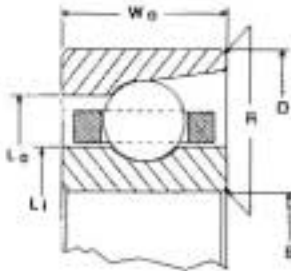

Large Thin Section Angular Contact Bearings have been developed to offer a maximum ball complement with a one piece precision machined retainer and are available in sizes up to 12" OD. The ball grooves are honed for precision, low torque, and quiet operation. The large ball complement, combined with a relatively high contact angle, maximizes axial stiffness. Rings and balls are normally 440C stainless steel, but other material options are available for specific applications.

Example P/N: TAO 104-120 SU

## Large Thin Section Series

Basic Bearing Size	Bore B	O.D. D	Width W <sub>o</sub>	Land Diameter		Radius R	Ball Complement		Load Ratings (lbs.)			Approx. Weight lbs.
				L <sub>i</sub>	L <sub>o</sub>		Size	Number	Radial		Thrust	
									C	R <sub>s</sub>	T <sub>s</sub>	
64-74	4.000	4.625	.3125	4.219	4.406	.040	5/32	66	2210	3345	2900	.26
64-76	4.000	4.750	.3750	4.263	4.488	.040	3/16	54	2615	3900	3420	.38
64-80	4.000	5.000	.5000	4.350	4.650	.060	1/4	42	4297	5480	4725	.69
68-76	4.250	4.750	.2500	4.425	4.575	.025	1/8	86	1632	2625	2420	.17
68-78	4.250	4.875	.3125	4.469	4.656	.040	5/32	68	2217	3460	2990	.28
68-80	4.250	5.000	.3750	4.513	4.738	.040	3/16	58	2906	4190	3670	.40
68-84	4.250	5.250	.5000	4.250	4.900	.060	1/4	44	4368	5745	4950	.72
72-80	4.500	5.000	.2500	4.675	4.825	.025	1/8	90	1651	2965	2535	.18
72-82	4.500	5.125	.3125	4.719	4.906	.040	5/32	72	2269	3670	3165	.29
72-84	4.500	5.250	.3750	4.763	4.988	.040	3/16	62	2990	4185	3925	.43
72-88	4.500	5.500	.5000	4.850	5.150	.060	1/4	46	4433	6025	5175	.77
76-84	4.750	5.250	.2500	4.925	5.075	.025	1/8	94	1677	3100	2645	.19
76-86	4.750	5.375	.3125	4.969	5.156	.040	5/32	76	2314	3885	3340	.31
76-88	4.750	5.500	.3750	5.013	5.238	.040	3/16	64	3010	4665	4050	.45
76-92	4.750	5.750	.5000	5.100	5.400	.060	1/4	50	4622	6580	5625	.81
76-100	4.750	6.250	.7500	5.275	5.725	.080	3/8	34	8190	9490	8610	1.91
80-88	5.000	5.500	.2500	5.175	5.325	.025	1/8	100	1723	3305	2815	.20
80-90	5.000	5.625	.3125	5.219	5.406	.040	5/32	80	2360	4100	3515	.32
80-92	5.000	5.750	.3750	5.263	5.488	.040	3/16	68	3094	4960	4305	.47
80-96	5.000	6.000	.5000	5.350	5.650	.060	1/4	52	4687	6850	5850	.85
80-104	5.000	6.500	.7500	5.525	5.975	.080	3/8	36	8411	10050	9115	2.00
88-96	5.500	6.000	.2500	5.675	5.825	.025	1/8	110	1788	3640	3095	.22
88-98	5.500	6.125	.3125	5.719	5.906	.040	5/32	88	2451	4525	3870	.35
88-100	5.500	6.250	.3750	5.763	5.988	.040	3/16	74	3185	5425	4685	.51
88-104	5.500	6.500	.5000	5.850	6.150	.060	1/4	56	4797	7260	6300	.92
88-112	5.500	7.000	.7500	6.025	6.475	.080	3/8	38	8522	10690	9620	2.16

R = The maximum radius of shaft or housing fillet that the bearing corner will clear.  
 C = Dynamic radial capacity @ 33 1/3 RPM for 2500 hours average life (L-10 life is 500 hours).  
 R<sub>s</sub> = Static radial capacity.  
 T<sub>s</sub> = Static thrust capacity.

# Angular Contact

## Large Thin Section Series

Basic Bearing Size	Bore B	O.D. D	Width W <sub>o</sub>	Land Diameter L <sub>i</sub> L <sub>o</sub>		Radius R	Ball Complement Size Number		Load Ratings (lbs.)			Approx. Weight lbs.
									Radial		Thrust	
									Dynamic C	Static R <sub>s</sub>	Static T <sub>s</sub>	
									96-104	6.000	6.500	
96-106	6.000	6.625	.3125	6.219	6.406	.040	5/32	96	2535	4950	4220	.38
96-108	6.000	6.750	.3750	6.263	6.488	.040	3/16	80	3276	5880	5065	.55
96-112	6.000	7.000	.5000	6.350	6.650	.060	1/4	62	5018	8010	6975	1.00
96-120	6.000	7.500	.7500	6.525	6.975	.080	3/8	42	8918	11880	10635	2.35
104-112	6.500	7.000	.2500	6.675	6.825	.025	1/8	128	1885	4265	3600	.27
104-114	6.500	7.125	.3125	6.719	6.906	.040	5/32	104	2613	5360	4570	.41
104-116	6.500	7.250	.3750	6.763	6.988	.040	3/16	86	3361	6340	5445	.60
104-120	6.500	7.500	.5000	6.850	7.150	.060	1/4	66	5122	8530	7425	1.07
104-128	6.500	8.000	.7500	7.025	7.475	.080	3/8	46	9289	13080	11645	2.53
112-120	7.000	7.500	.2500	7.175	7.325	.025	1/8	138	1937	4600	3885	.29
112-122	7.000	7.625	.3125	7.219	7.406	.040	5/32	112	2685	5790	4925	.44
112-124	7.000	7.750	.3750	7.263	7.488	.040	3/16	94	3497	6965	5950	.64
112-128	7.000	8.000	.5000	7.350	7.650	.060	1/4	72	5317	9370	8100	1.15
112-136	7.000	8.500	.7500	7.525	7.975	.080	3/8	48	9380	13700	12150	2.69
120-128	7.500	8.000	.2500	7.675	7.825	.025	1/8	148	1989	4950	4165	.31
120-130	7.500	8.125	.3125	7.719	7.906	.040	5/32	118	2730	6110	5185	.47
120-132	7.500	8.250	.3750	7.763	7.988	.040	3/16	100	3569	7415	6330	.68
120-136	7.500	8.500	.5000	7.850	8.150	.060	1/4	76	5408	9890	8550	1.22
120-144	7.500	9.000	.7500	8.025	8.475	.080	3/8	52	9718	14905	13165	2.87
128-136	8.000	8.500	.2500	8.175	8.325	.025	1/8	156	2022	5220	4390	.32
128-138	8.000	8.625	.3125	8.219	8.406	.040	5/32	126	2795	6535	5540	.50
128-140	8.000	8.750	.3750	8.263	8.488	.040	3/16	106	3647	7870	6710	.73
128-144	8.000	9.000	.5000	8.350	8.650	.060	1/4	80	5499	10450	9000	1.31
128-152	8.000	9.500	.7500	8.525	8.975	.080	3/8	56	10036	16250	14175	3.05
144-152	9.000	9.500	.2500	9.175	9.325	.025	1/8	176	2119	5905	4950	.36
144-154	9.000	9.625	.3125	9.219	9.406	.040	5/32	142	2925	7390	6240	.56
144-156	9.000	9.750	.3750	9.263	9.488	.040	3/16	120	3829	8925	7595	.82
144-160	9.000	10.000	.5000	9.350	9.650	.060	1/4	90	5753	11815	10125	1.46
144-168	9.000	10.500	.7500	9.525	9.975	.080	3/8	62	10413	18600	15695	3.40
160-168	10.000	10.500	.2500	10.175	10.325	.025	1/8	196	2204	6590	5515	.40
160-170	10.000	10.625	.3125	10.219	10.406	.040	5/32	158	3049	8235	6945	.61
160-172	10.000	10.750	.3750	10.263	10.488	.040	3/16	132	3959	9860	8355	.91
160-176	10.000	11.000	.5000	10.350	10.650	.060	1/4	100	5993	13170	11250	1.61
160-184	10.000	11.500	.7500	10.525	10.975	.080	3/8	68	10758	19850	17215	3.74
176-184	11.000	11.500	.2500	11.175	11.325	.025	1/8	214	2275	7205	6020	.44
176-186	11.000	11.625	.3125	11.219	11.406	.040	5/32	172	3140	8990	7560	.67
176-188	11.000	11.750	.3750	11.263	11.488	.040	3/16	144	4082	10775	9115	.99
176-192	11.000	12.000	.5000	11.350	11.650	.060	1/4	110	6214	14515	12375	1.76

R = The maximum radius of shaft or housing fillet that the bearing corner will clear.  
 C = Dynamic radial capacity @ 33 1/3 RPM for 2500 hours average life (L-10 life is 500 hours).  
 R<sub>s</sub> = Static radial capacity.  
 T<sub>s</sub> = Static thrust capacity.

# Fractured Race Commercial Series

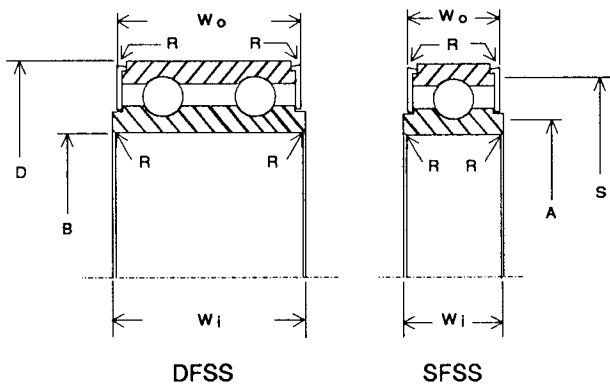

Split Ballbearing SFSS and DFSS single and double row precision ground ball bearings are of thin section design with a full race complement for maximum capacity. Deep groove races are symmetrically ground and uninterrupted by filling slots. Double shielding is incorporated for grease retention and contamination protection.

Type SFSS and DFSS offer the highest load carrying capacities for limited bearing space. They achieve optimum performance for applications having moderate speeds and maximum radial load requirements. In addition, type DFSS with a built-in 15° contact angle provides maximum resistance to overturning loads.

Most sizes have equivalent cross section and are interchangeable with standard needle bearings.

Catalog Number	B Bore +.0000 -.0005	D O.D. +.0005 -.0000	Width		S		A		Balls		Capacity (lbs.)		App. Weight (lbs.)
			W <sub>o</sub> +.000 -.010	W <sub>i</sub> +.000 -.005	Max. Housing Shoulder Diameter	Min. Housing Shoulder Diameter	Inner Race Shoulder Diameter	Min. Shaft Shoulder Diameter	Size	Number	C	R <sub>s</sub>	
DFSS-07 SFSS-07	.4375	1.0000	.565 .315	.625 .375	.875	.841	.600	.537	1/8	18	1573 962	1020 510	.07 .04
DFSS-08 SFSS-08	.5000	1.0000	.565 .315	.625 .375	.875	.841	.600	.600	1/8	18	1573 962	1020 510	.07 .04
DFSS-10 SFSS-10	.6250	1.1250	.565 .315	.625 .375	1.000	.966	.725	.725	1/8	21	1801 1060	1200 600	.08 .04
DFSS-12 SFSS-12	.7500	1.2500	.565 .315	.625 .375	1.125	1.091	.850	.850	1/8	24	1859 1157	1380 690	.09 .05
DFSS-14 SFSS-14	.8750	1.3750	.565 .315	.625 .375	1.250	1.216	.975	.975	1/8	28	1989 1222	1600 800	.10 .06
DFSS-16 SFSS-16	1.0000	1.5000	.565 .315	.625 .375	1.375	1.341	1.100	1.100	1/8	31	2087 1287	1760 880	.11 .06
DFSS-18 SFSS-18	1.1250	1.6250	.565 .315	.625 .375	1.500	1.465	1.225	1.225	1/8	34	2184 1352	1940 970	.13 .07
DFSS-20 SFSS-20	1.2500	1.7500	.565 .315	.625 .375	1.625	1.591	1.350	1.350	1/8	37	2249 1378	2100 1050	.14 .08
DFSS-22 SFSS-22	1.3750	1.8750	.565 .315	.625 .375	1.750	1.716	1.475	1.475	1/8	40	2340 1443	2280 1140	.15 .08
DFSS-24 SFSS-24	1.5000	2.0000	.565 .315	.625 .375	1.875	1.841	1.600	1.600	1/8	43	2444 1508	2440 1220	.16 .09

C = Dynamic radial capacity @ 33 1/3 RPM for 2500 hours average life (L-10 life is 500 hours).

R<sub>s</sub> = Static radial capacity.

R = .015 maximum shaft or housing fillet that the bearing corner will clear.

Catalog numbers SFSS and DFSS-07, 08 and 10 are also available in commercial grade with bore to +.0010/-.0015 tolerance.

Add prefix "M" to catalog number.

Examples: MSFSS-07 or MDFSS-07.

Considerable cost savings are possible.

Radial Play: Thru DFSS 12= .0005/.0015 Thru SFSS 24= .0005/.0015  
Over DFSS 12= .0005/.0020

Use suffix "Z" in place of "S" for sealed bearings which are available on special order.

Examples: SFSZ-07 (shield on one side—seal on the other).

SFZZ-07 (double seals).



# Tolerances

Split Ballbearing Division manufactures Thin Section Bearings in three standard quality grades.

**Instrument Quality:** SBB "U" and "SU" should be specified for precision instrument applications where low torque, precise location and ultra quiet running properties are necessary. Races are precision honed on specially built equipment to provide extremely smooth running performance.

**Precision Quality:** SBB "P" grade is used in less precise applications that do not require the close mounting fits and low torque levels associated with instrument applications. SBB "P"

grade is approximately equivalent in mounting tolerances and performance to ABEC 1 & 3.

**Diameter Tolerances:** Bore and OD tolerances are shown as mean diameter. Maximum and minimum out-of-round tolerances are not shown since the bearings are relatively thin section and will conform to the roundness of the housing or shaft when mounted. Out-of-roundness of thin section bearings has little functional significance.

**How To Specify:** Add Tolerance Grade as part number suffix "SU", "U" or "P".

SBB TOLERANCE CODE	TOLERANCES ARE IN .0001 INCHES											
	INNER RING						OUTER RING					
	BEARING BORE SIZE NO. DIA. (IN.) X 16	BORE DIAMETER MEAN	RADIAL RUNOUT	FACE PARALLELISM	BORE RUNOUT TO REF. FACE	GROOVE RUNOUT TO REF. FACE	BEARING O.D. SIZE NO. DIA. (IN.) X 16	OUTSIDE DIAMETER MEAN	RADIAL RUNOUT	FACE PARALLELISM	O.D. RUNOUT TO REF. FACE	GROOVE RUNOUT TO REF. FACE
SU	64 thru 72	+0, -3	+2	+2	+2	+2	74 thru 112	+0, -4	+3	+2	+2	+3
	76 thru 144	+0, -4	+3	+2	+2	+3	120 thru 144	+0, -4	+4	+3	+3	+4
	160 thru 176	+0, -5	+4	+3	+3	+4	160 thru 192	+0, -5	+4	+3	+3	+4
U	64 thru 72	+0, -4	+3	+3	+3	+4	74 thru 88	+0, -5	+4	+3	+3	+5
	76 thru 144	+0, -5	+4	+4	+4	+5	96 thru 144	+0, -5	+5	+4	+4	+6
	160 thru 176	+0, -6	+5	+5	+5	+6	160 thru 192	+0, -6	+6	+5	+5	+7
P	64 thru 72	+3, -5	+6	+5	+5	+6	74 thru 104	+0, -8	+8	+8	+8	+8
	76 thru 112	+3, -6	+8	+7	+7	+8	74 thru 104	+0, -8	+8	+8	+8	+8
	120 thru 144	+3, -7	+8	+8	+8	+8	112 thru 144	+0, -10	+10	+10	+10	+10
	160 thru 176	+3, -8	+10	+10	+10	+10	160 thru 192	+0, -12	+12	+10	+10	+12

Width Tolerances: Single Bearing: 64-74 thru 176-192 = +.000, -.005

Duplexed Sets: 64-74 thru 112-136 = +.000, -.030  
 120-128 thru 176-192 = +.000, -.040 } Total/Set

# Inch to Metric Conversions

The following conversions are based upon 1 inch = 25.4 millimeters exactly and are intended for estimating purposes only. When converting for design or engineering needs, we suggest actually calculating or consulting MPB for assistance in your specific application.

All inch dimensions appear in the tabular data on pages 4-9, and 28-32.

INCH-MM		INCH-MM		INCH-MM		INCH-MM		INCH-MM		INCH-MM	
0.0100	0.25	1.2100	30.73	2.6750	67.95	4.7630	120.98	6.4060	162.71	8.3500	212.09
0.0150	0.38	1.2160	30.89	2.7190	69.06	4.8500	123.19	6.4750	164.47	8.4060	213.51
0.0250	0.64	1.2250	31.12	2.7840	70.71	4.8750	123.83	6.4880	164.80	8.4750	215.27
0.0400	1.02	1.2300	31.24	2.8125	71.44	4.9000	124.46	6.5000	165.10	8.4880	215.60
0.0600	1.52	1.2350	31.37	2.8250	71.76	4.9250	125.10	6.5250	165.74	8.5000	215.90
0.0800	2.03	1.2500	31.75	2.8750	73.03	4.9690	126.21	6.6250	168.28	8.5250	216.54
0.1562	3.97	1.3125	33.34	2.9060	73.81	4.9880	126.70	6.6500	168.91	8.6250	219.08
0.1875	4.76	1.3330	33.86	3.0000	76.20	5.0000	127.00	6.6750	169.55	8.6500	219.71
0.1960	4.98	1.3410	34.06	3.0100	76.45	5.0130	127.33	6.7190	170.66	8.7500	222.25
0.2500	6.35	1.3500	34.29	3.0340	77.06	5.0750	128.91	6.7500	171.45	8.9750	227.97
0.2810	7.14	1.3600	34.54	3.0625	77.79	5.1000	129.54	6.7630	171.78	9.0000	228.60
0.3125	7.94	1.3750	34.93	3.1250	79.38	5.1250	130.18	6.8250	173.36	9.1750	233.05
0.3150	8.00	1.4170	35.99	3.1750	80.65	5.1500	130.81	6.8500	173.99	9.2190	234.16
0.3750	9.53	1.4580	37.03	3.2190	81.76	5.1560	130.96	6.9060	175.41	9.2630	235.28
0.4375	11.11	1.4650	37.21	3.2500	82.55	5.1750	131.45	6.9750	177.17	9.3250	236.85
0.4580	11.63	1.4750	37.47	3.2570	82.73	5.2190	132.56	6.9880	177.50	9.3500	237.49
0.5000	12.70	1.5420	39.17	3.3250	84.46	5.2380	133.05	7.0000	177.80	9.4060	238.91
0.5370	13.64	1.5625	39.69	3.3770	85.78	5.2500	133.35	7.0250	178.44	9.4880	241.00
0.5420	13.77	1.5830	40.21	3.4060	86.51	5.2630	133.68	7.1250	180.98	9.5000	241.30
0.5650	14.35	1.5910	40.41	3.5000	88.90	5.2750	133.99	7.1250	180.98	9.5250	241.94
0.5880	14.94	1.6000	40.64	3.6000	91.44	5.3250	135.26	7.1500	181.61	9.6250	244.48
0.6000	15.24	1.6060	40.79	3.6250	92.08	5.3500	135.89	7.2190	183.36	9.6500	245.11
0.6250	15.88	1.6250	41.28	3.6750	93.35	5.3750	136.53	7.2500	184.15	9.7500	247.65
0.6720	17.07	1.6400	41.66	3.7190	94.46	5.4000	137.16	7.2630	184.48	9.9750	253.37
0.7130	18.11	1.6670	42.34	3.8250	97.16	5.4060	137.31	7.3250	186.06	10.0000	254.00
0.7250	18.42	1.7070	43.36	3.8750	98.43	5.4880	139.40	7.3500	186.69	10.1750	258.45
0.7500	19.05	1.7080	43.38	3.9060	99.21	5.5000	139.70	7.4060	188.11	10.2190	259.56
0.7800	19.81	1.7160	43.59	4.0000	101.60	5.5250	140.34	7.4750	189.87	10.2630	260.68
0.7970	20.24	1.7350	44.07	4.1250	104.78	5.6250	142.88	7.4880	190.20	10.3250	262.26
0.8380	21.29	1.7500	44.45	4.1750	106.05	5.6500	143.51	7.5000	190.50	10.3500	262.89
0.8410	21.36	1.7920	45.52	4.2190	107.16	5.6750	144.15	7.5250	191.14	10.4060	264.31
0.8500	21.59	1.8125	46.04	4.2500	107.95	5.7190	145.26	7.6250	193.68	10.4880	266.40
0.8750	22.23	1.8410	46.76	4.2630	108.28	5.7250	145.42	7.6500	194.31	10.5000	266.70
0.8930	22.68	1.8560	47.14	4.3250	109.86	5.7500	146.05	7.6750	194.95	10.5250	267.34
0.9180	23.32	1.8750	47.63	4.3500	110.49	5.7630	146.38	7.7190	196.06	10.6250	269.88
0.9220	23.42	1.9470	49.45	4.4060	111.91	5.8250	147.96	7.7500	196.85	10.6500	270.51
0.9580	24.33	2.0000	50.80	4.4250	112.40	5.8500	148.59	7.7630	197.18	10.7500	273.05
0.9660	24.54	2.0625	52.39	4.4690	113.51	5.9060	150.01	7.8250	198.76	10.9750	278.77
0.9750	24.77	2.0970	53.26	4.4880	114.00	5.9750	151.77	7.8500	199.39	11.0000	279.40
1.0000	25.40	2.1750	55.24	4.5000	114.30	5.9880	152.10	7.9060	200.81	11.1750	283.85
1.0200	25.91	2.2190	56.36	4.5130	114.63	6.0000	152.40	7.9750	202.57	11.2190	284.96
1.0420	26.47	2.2500	57.15	4.5750	116.21	6.0250	153.04	7.9880	202.90	11.2630	286.08
1.0430	26.49	2.2620	57.45	4.6000	116.84	6.1250	155.58	8.0000	203.20	11.3250	287.66
1.0625	26.99	2.3125	58.74	4.6250	117.48	6.1500	156.21	8.0250	203.84	11.3500	288.29
1.0910	27.71	2.3250	59.06	4.6500	118.11	6.1750	156.85	8.1250	206.38	11.4060	289.71
1.1000	27.94	2.4060	61.11	4.6560	118.26	6.2190	157.96	8.1500	207.01	11.4880	291.80
1.1250	28.58	2.4120	61.26	4.6750	118.75	6.2500	158.75	8.1750	207.65	11.5000	292.10
1.1400	28.96	2.5210	64.03	4.7190	119.86	6.2500	158.75	8.2190	208.76	11.6250	295.28
1.1450	29.08	2.5625	65.09	4.7380	120.35	6.2630	159.08	8.2500	209.55	11.6500	295.91
1.1680	29.67	2.6250	66.68	4.7500	120.65	6.3250	160.66	8.2630	209.88	11.7500	298.45
1.1875	30.16	2.6630	67.64	4.7500	120.65	6.3500	161.29	8.3250	211.46	12.0000	304.80

## MPB Division Capabilities:

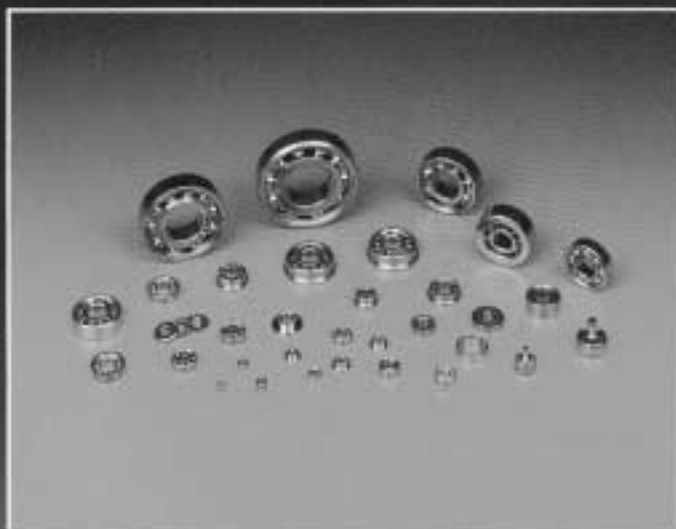

Standard Miniature and Instrument Ball Bearings



Standard and Special Thin Section and Torque Tube Bearings



Special Bearings Customized to your Specifications



Precision Gimbal and Rotating Assemblies

MPB produces a wide range of bearings and bearing products serving the aircraft/aerospace, computer dental, medical, communication and numerous other industries. For more information on MPB products, consult your Factory-Trained MPB Sales Engineer, or contact MPB Customer

Service, Timken Aerospace & Super Precision Bearings, MPB Division,  
P.O. Box 547, Keene, NH 03431.  
Tel. 603-352-0310



A TIMKEN COMPANY SUBSIDIARY



Timken Aerospace & Super Precision Bearings – MPB Division, Keene, New Hampshire

Engineering innovation, manufacturing excellence and service responsiveness. These qualities have driven Timken Aerospace & Super Precision Bearings for over fifty years and make it what it is today - a technological leader in bearings for aerospace, medical / dental, computer, robotics and industrial applications. Timken Aerospace & Super Precision Bearings has an accessible and experienced engineering staff and over 500,000 square feet of modern manufacturing space including a facility dedicated to precision assemblies.

## Timken Aerospace & Super Precision Bearings USA Sales & Manufacturing Divisions:

### MPB Division, Keene, NH

Standard and special precision miniature and instrument bearings .059" to 1.5" OD, thin section bearings .625" to 6.0" OD, airframe bearings, computer disk spindles, and precision gimbaled and rotary assemblies.

Tel: 603-352-0310, Fax: 603-355-4553

E-Mail: [mpb@timken.com](mailto:mpb@timken.com)

Internet: <http://www.timken.com/mpb>

### SBB Division, Lebanon, NH

Standard and special high precision ball and roller bearings, and integral assemblies, to 24" OD.

Tel: 603-448-3000, Fax: 603-443-5202

### Timken Aerospace Bearing Services (PBC), West Lebanon, NH

FAA/JAA - approved center for remanufacturing of aircraft bearings.

Tel: 603-298-6155, Fax: 603-298-6157

### Handpiece Headquarters, Orange, CA

Repair and overhaul of dental handpieces and distribution of handpiece replacement parts.

Tel: 714-685-3070, Fax: 714-921-1852

## International Sales Offices:

### EUROPE / AFRICA

Timken Aerospace & Super Precision Bearings - Europa BV  
Overloek 9, 1671 GD Medemblik  
P.O. Box 27, 1670AA Medemblik  
The Netherlands  
Tel: (0) 227-542344, Fax: (0) 227-544552

### FRANCE

Timken Aerospace & Super Precision Bearings - Europa BV  
Succursale, France  
14 Bureau A101  
Bis, rue de Mal Foch  
77780 Bourron-Marlotte  
Tel: (0) 1 64459880, Fax: (0) 1 64459830

### GERMANY / AUSTRIA / SWITZERLAND

Timken Aerospace & Super Precision Bearings - Europa BV  
Beratungs- und Verkaufsniederlassung  
Obertronstrasse, 3  
D-97737 Gemunden am Main  
Germany  
Tel: (0) 9351 - 3013, Fax: (0) 9351 - 2974

### ISRAEL

RDT Components Ltd.  
P.O. Box 58013  
61580 Tel Aviv, Israel  
Tel: 3 6450707, Fax: 3 6492413

### ITALY

GIMAR di D.F. e M. Giordano  
via Busoni 7a  
20137 Milano, Italy  
Tel: (0) 2-5518918 / 5512004, Fax: (0) 2 - 5466163

### SCANDINAVIA

Svensson & Svensson Ingenjorsfirma AB  
P.O. Box 141  
S-691 23 Karlskoga, Sweden  
Tel: (0) 586-371 50, Fax: (0) 586-379 80

### SINGAPORE

Timken Aerospace & Super Precision Bearings - Singapore PTE Ltd.  
Block 1, Kallang Sector, #06-04  
Singapore 349276  
Tel: 65 841-4380, Fax: 65 841-4485

### UNITED KINGDOM

Timken Aerospace & Super Precision Bearings - UK Ltd.  
P.O. Box 667, Upper Villiers Street, Wolverhampton  
West Midlands, WV2 4UH, England  
Tel: (0) 1902-773300, Fax: (0) 1902-771448



## Timken Aerospace & Super Precision Bearings MPB Division - A Unit of The Timken Company

Precision Park, Keene, New Hampshire 03431-0547, Tel: 603-352-0310, Fax: 603-355-4553



*Manufacturing a full range of standard instrument bearings.*



*Specializing in solving unique application problems.*



*Excelling in producing precision rotating assemblies.*

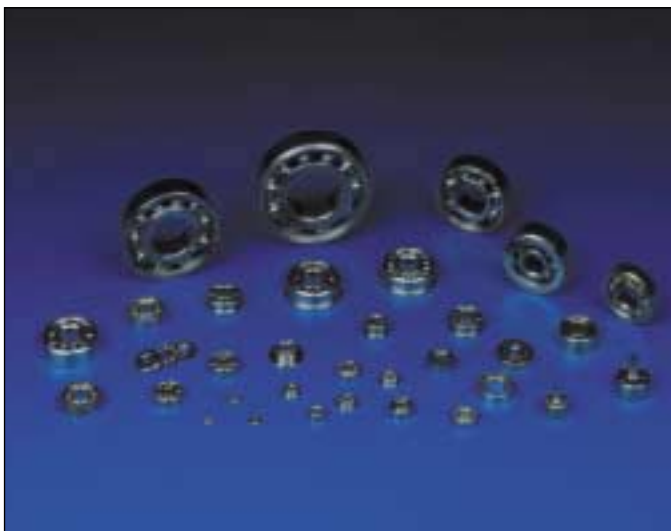

*Producing special miniature bearings as small as .059" OD.*

**T**imken Super Precision produces a wide range of bearing products serving the aircraft/aerospace, computer, dental, medical, and numerous other industries. For more information on our products, consult your Timken Super Precision Sales Engineer, or contact Inside Sales, Timken Super Precision, P.O. Box 547, Keene, New Hampshire 03431. Tel. (603) 352-0310. Visit us at [www.timken.com/superprecision](http://www.timken.com/superprecision)

## Manufacturing Divisions:

### **Timken Super Precision, Keene, NH**

Standard and special precision miniature and instrument "bearings .059" to 1.5" OD, thin section bearings .625" to 6.0" OD, air-frame bearings, computer disk spindles, and precision gimbal and rotary assemblies.

Tel: 603-352-0310, Fax: 603-355-4553

E-Mail: [mpbbox@timken.com](mailto:mpbbox@timken.com)

Internet: <http://www.timken.com/superprecision>

### **Timken Aerospace, Lebanon, NH**

Standard and special high precision ball and roller bearings and integral assemblies, to 24" OD.

Tel: 603-448-3000, Fax: 603-443-5202

### **Timken Aerospace Services, Lebanon, NH**

FAA/JAA - approved center for remanufacturing of aircraft bearings.

Tel: 603-448-3000, Fax: 603-443-8910

### **Handpiece Headquarters, Orange, CA**

Repair and overhaul of dental handpieces and distribution of handpiece replacement parts.

Tel: 800-557-7867 • 714-685-3070, Fax: 714-921-1852

E-Mail: [handpiece@timken.com](mailto:handpiece@timken.com)

Internet: <http://www.handpieceheadquarters.com>

### **Timken Aerospace & Super Precision Bearings - Europa BV Medemblik, The Netherlands**

Assembly of precision miniature and instrument bearings and precision bearing products.

Tel: (31) (0) 227 - 542344, Fax: (31) (0) 227 - 544552

### **Timken Aerospace & Super Precision Bearings - UK Wolverhampton, England**

Standard and special precision ball and roller bearings for aerospace mainshaft, gearbox and transmission applications to 18.5" OD.

Tel: (44) (0) 1902 - 773300, Fax: (44) (0) 1902 - 771448

### **Timken Aerospace & Super Precision Bearings - Singapore PTE Ltd., Kallang, Singapore**

Assembly of precision miniature and instrument bearings and precision bearing products.

### **Timken Aerospace & Super Precision Bearings serves both OEM and aftermarkets throughout the world.**

Tel: (65) 6841 - 4380, Fax: (65) 6841 - 4485

## International Sales Offices:

### **EUROPE / AFRICA**

Timken Aerospace & Super Precision Bearings - Europa BV  
Overleek 9, 1671GD Medemblik

P.O. Box 27, 1670AA Medemblik

The Netherlands

Tel: (31) (0) 227 - 542344, Fax: (31) (0) 227 - 544552

### **FRANCE**

Timken Aerospace & Super Precision Bearings - Europa BV  
Succersale, France

Bureau A101

14 Bis, rue de Mal Foch

77780 Bourron-Marlotte

Tel: (33) (0) 1 64459880, Fax: (33) (0) 1 64459830

### **GERMANY / AUSTRIA / SWITZERLAND**

Timken Aerospace & Super Precision Bearings - Europa BV  
Beratungs - und verkaufsniederlassung

Obertorstrasse, 3

D-97737 Gemunden am Main

Germany

Tel: (49) (0) 9351 - 3013, Fax: (49) (0) 2 - 5466163

### **ISRAEL**

Avnet Components Israel Ltd

Avnet Building P.O. Box 48

South Drorim Commerce Center

Tel-Mond 406000 Israel

Tel: (972) 9 7966999, Fax: (972) 3 7691115

### **ITALY**

GIMAR di D.F. e M. Giordano

via Busoni 7a

20137 Milano, Italy

Tel: (39) (0) 2 - 5516918 / 5512004, Fax: (39) (0) 2 - 5466163

### **SCANDINAVIA**

Svensson & Svensson Ingenjorsfirma AB

P.O. Box 141

S-691 23 Karlskoga, Sweden

Tel: (46) (0) 586 - 371 50, Fax: (46) (0) 586 - 379 80

### **SINGAPORE**

Timken Aerospace & Super Precision Bearings -  
Singapore PTE Ltd.

Block 1, Kallang Sector, #06-04

Singapore 349276

Tel: (65) 6841 - 4380, Fax: (65) 6841 - 4485

### **UNITED KINGDOM**

Timken Aerospace & Super Precision Bearings - UK

P.O. Box 667, Upper Villers Street, Wolverhampton

West Midlands, WV2 4UH, England

Tel: (44) (0) 1902 - 773300, Fax: (44) (0) 1902 - 771448

# *Ideas in Motion*

Timken® is a registered trademark of  
The Timken Company  
[www.timken.com](http://www.timken.com)

# TIMKEN

© 2002 The Timken Company  
Printed in the USA  
1M-07-02 Order No. 5911

WORLDWIDE LEADER IN BEARINGS AND STEEL